

**JURUNATURE** SDN BHD

*Your First Choice Partner in Oil and Gas*



COMPANY

**PROFILE**

www.jurunature.com



**JURUNATURE SDN BHD**

*Your First Choice Partner in Oil and Gas*

Suite 4-07, Level 4  
AMODA Building  
22 Jalan Imbi  
55100 Kuala Lumpur, Malaysia

Tel: +6 03 2711 1011  
Fax: +6 03 2711 1022

Website: [www.jurunature.com](http://www.jurunature.com)  
Email: [sales@jurunature.com](mailto:sales@jurunature.com)





## TABLE OF CONTENTS

COMPANY BACKGROUND .....	4
Profile.....	4
Corporate Information .....	5
Vision, Mission, and Shared Values.....	6
Company Policy .....	8
COMPANY STRUCTURE .....	9
Organization Chart.....	9
Our people .....	10
BUSINESS ACTIVITIES.....	12
PRODUCT AND SERVICES.....	14
Fabrication Works .....	16
HUMIDUR® Single Coating System .....	24
HiCO <sub>2</sub> Dry Ice Blasting.....	41
Passive Fire Protection .....	51
<i>JURUNATURE's</i> PFP Casting System .....	52
JuruFlex - J120 - Jet Fire Jacket System .....	54
Fire & Blast Protective Systems.....	55
Fire Rated Doors.....	56
FRP Grating Systems .....	57
Welding Electrodes .....	58
Field Joint Coatings .....	59
Enerthem Sprayable Insulating Coating.....	60
C-Saddle Pipe Supports .....	61
Topside Robotic Inspection.....	62
Emission Monitoring and Reporting .....	63
Dredging & Land Reclamation, Offshore, Environmental, Infra Marine.....	64
Vegase – Safety Engineering in Gas Detection, Liquid Hydrocarbon .....	70
ProTXcoat – High Temperature Insulation and Repair Coating .....	73





Sacrificial Anodes with Induction Melting Technology.....	80
RECOAT Antimicrobial Protective Coating System .....	85
VSAT Systems and ICT Solutions .....	88
HEALTH, SAFETY & ENVIRONMENT .....	89
Major HSE Appreciation.....	91
Petronas – BOKOR CPP Phase 3 Redevelopment Project Awards .....	92
QUALITY ASSURANCE & CONTROL.....	95
Quality.....	95
Quality Policy .....	96
ISO CERTIFICATIONS .....	97
CLIENTELES & KEY ACCOUNTS.....	98
KEY INTERNATIONAL PARTNERS .....	99
LICENSES AND CERTIFICATIONS .....	100





## COMPANY BACKGROUND

### Profile

**JURUNATURE SDN. BHD.** (hereinafter also referred to as “**JURUNATURE**”) was incorporated and registered on 8<sup>th</sup> April 1999 with the intention of focusing in trading of niche products and providing best-in-class services, specializing in the Oil and Gas (O & G) / Petrochemical industry. As a prudent company and in order to succeed in this highly competitive trade, the Company realized the need to aggressively research the global markets for products that are innovative, practical and much sought after by the Oil and Gas industry.

After an extensive 10 months of deliberation and fact-finding on products, **JURUNATURE** became active and began securing partnership arrangements and pairing-up with major international trading companies beginning March 1, 2000.

Today, **JURUNATURE** is proud to be credited as a system and service provider of innovative safety solutions to the oil & gas petrochemical industry. We endeavor to tailor a package that provides the most technically advanced system, product, and service solution that meets the budgetary constraints of our clients.

Through an extensive knowledge of the industry from the inside as a client and from the outside as an EPIC Contractor, **JURUNATURE** has developed a complex yet highly effective and sophisticated global network of suppliers and partners, which we truly believe that **JURUNATURE** have mastered the discipline of smart-partnering.

**JURUNATURE** has successfully collaborated with distinguished and leading international companies in representing their presence in Malaysia. Numerous leading international companies have shown their absolute confidence in the Company by appointing the Company to be their **EXCLUSIVE** Agent/Partner in Malaysia.





## Corporate Information

Registered name of Company	:	<b>JURUNATURE SDN. BHD.</b>
Date of incorporation	:	8 <sup>th</sup> April, 1999
Office address	:	Suite 4 – 07, Level 4, AMODA Building, 22 Jalan Imbi, 55100 Kuala Lumpur
Telephone	:	+6 03 – 2711 1011
Fax	:	+6 03 – 2711 1022
Authorized Capital	:	RM 5,000,000.00
Paid-up Capital	:	RM 1,000,000.00
Board of Directors	:	Dato' Sri Muhammad Syafiq Bin Abdullah Datin Sri Dr. Maison Binti Shaik Abdul Rahman Abdul Hanif Bin Abu Bakar
Company Secretary	:	HOMELAND Consulting Sdn Bhd ( Tan Yen Nee – MAICSA 7026045 )
Banker's Name and Address	:	ALLIANCE BANK MALAYSIA BERHAD 150 – 152, Jalan Cerdas, Taman Connaught, 56000 Cheras, Kuala Lumpur
Accountant	:	NASHARUDDIN WONG & CO 3A01, Block A Pusat Dagangan Phileo Damansara 1 Jalan 16/11, Off Jalan Damansara 46350 Petaling Jaya, Selangor
Certifications	:	ISO 9001 : 2015 Quality Management System ISO 45001 : 2018 Occupational Health & Safety ISO 14001 : 2015 Environmental Management





## Vision, Mission, and Shared Values

### Core Values

Focus on customers	We always strive to exceed customers' expectations.
Deliver results	We are driven by result through innovation and continuous improvement.
Value people	We work as a team, respect and care for one another.
Uphold integrity	We demonstrate integrity in our words and actions.
Mutual respect and trust	In everything we do, in every interaction, both, we strive to operate with the upmost mutual respect and trust in every interaction both internally and externally
Open communication	Partnerships with our customers and co-workers must be based on trust, professionalism and transparency.

### Philosophy

**JURUNATURE** will keep contributing positively to the achievement of Malaysia's VISION 2020 by developing and growing our resources and increasing our competence in our specialized fields of work.

**JURUNATURE** will maintain the highest level of Quality, Safety and Environmental standards and awareness in all work that we undertake, no matter the size and that we will continue to ensure all work done is done to the highest level of client satisfaction.

**JURUNATURE** will continue to be a company with a strong Corporate Social Responsibility and it is our aim to continually honour our obligations to our shareholders, employees, stakeholders, clients and partners.





## Vision

**"Your First Choice Partner in Oil & Gas"**

## Mission

- Creating values in the Oil and Gas market by providing high end technology solutions and offerings in line with Malaysia's aspiration to be an innovation-led economy.
- We strive to be the global leader in providing products and services of unsurpassed quality for the oil and gas industries, adding value to all of our clients as well as exceeding their expectations.
- To exceed the needs and expectations of our customers at all times by continuously providing high quality products and services, complying fully with their specified requirements on time and within budget.
- Enhance our shareholders' value through its employees and providing a dynamic environment for both our employees and sub-contractors by creating an atmosphere of optimism, teamwork, creativity, resourcefulness.







## Company Policy

With qualified and technically experienced staff, the company is maturing into a vast and dynamic organization. Continuing to strive for excellence, the company is stepping up efforts in being recognized as a major trading company with unmatched records in all fields the Company ventures into.

Our company policies are:

- To strive for excellence and be recognized as THE leading company in its field of business.
- To establish and maintain good working and mutually beneficial relationship with all clients.
- To sustain the highest Safety and Health standards and to ensure the Safety and Health of its employees are given the highest priority.
- To ensure highest standards in ethics and integrity are complied with.
- To be very competitive in pricing, yet uncompromising in the quality and professionalism of work completed, and
- To be sensitive to the environment and conserve the state of the environment.





# COMPANY STRUCTURE

## Organization Chart



### COMPANY STRUCTURE

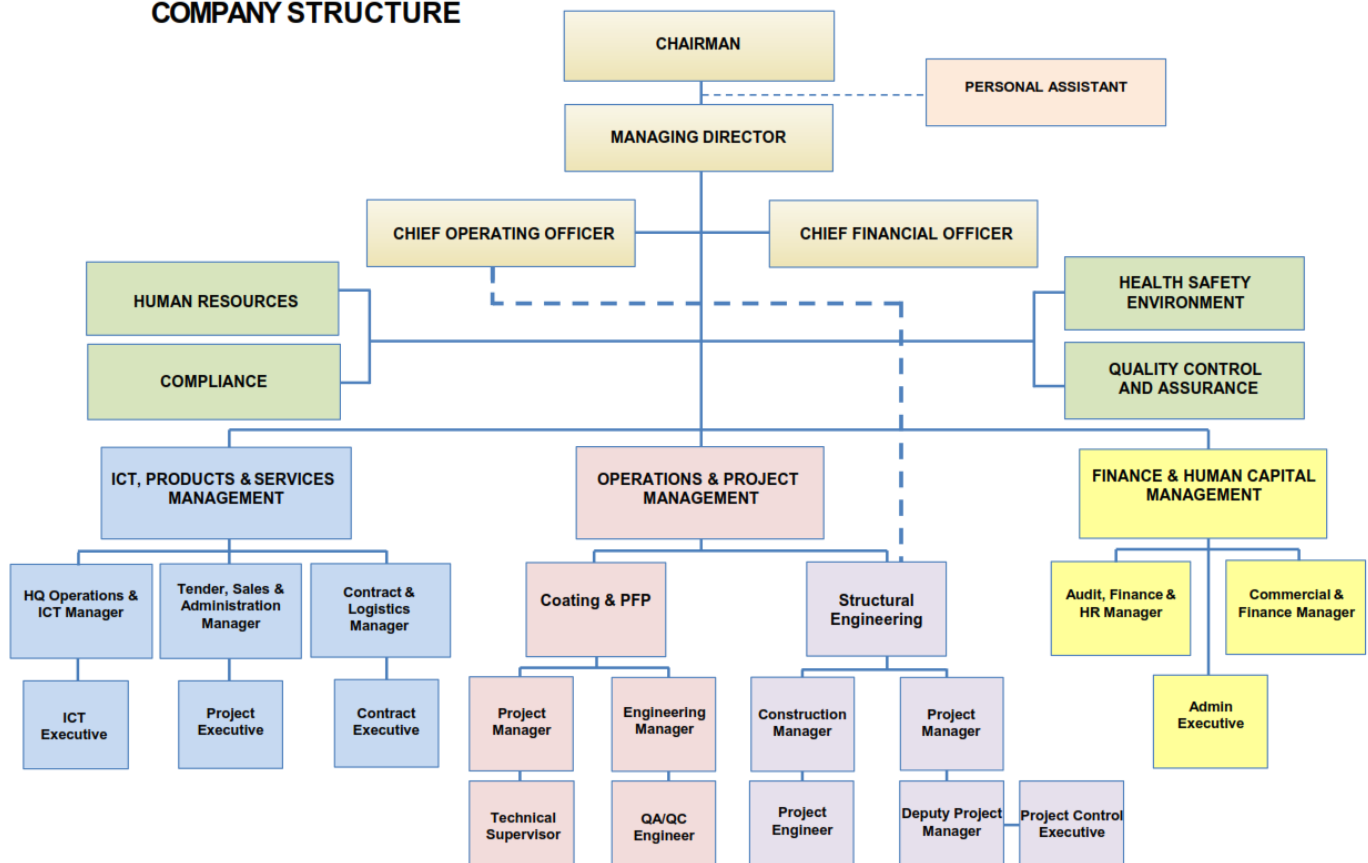



## Our people



We understand that our people are the key to our success and we're committed to:

- **Fostering a culture based on our beliefs and behaviors** – Our beliefs unite us to do the right thing, help others and realize potential and are supported by a set of behaviors that ask us to be authentic and respectful, work together and create value through excellence.
- **Improving health, wellbeing and lifestyle** – providing a safe and healthy work environment, as well as a range of benefits to ensure work/life balance.
- **Providing career development opportunities** – supporting individual goals, providing career paths and ensuring performance is matched by reward.
- **Fostering a culture of achievement** - through providing innovative learning opportunities.
- **Flexible working** - providing real choices to manage the balance between work and personal life.
- **An inclusive workplace environment** – creating a culture where men and women from an array of different backgrounds, generations and cultures feel genuinely included and valued.
- **Creating opportunities for community involvement** – through opportunities to work directly on community activities, providing support and processes to make this happen or by taking time to give back.







## BUSINESS ACTIVITIES

**JURUNATURE** as an EPIC Contractor, **JURUNATURE** has developed a complex and yet highly effective and sophisticated global network of suppliers and partners.

In the area of product offer, **JURUNATURE** has successfully collaborated with distinguished and leading international companies in representing their presence in Malaysia. Several leading international companies have shown their absolute confidence in the Company by appointing the Company to be their EXCLUSIVE Agent/Partner in Malaysia.



MLNG 3 SLUGCATCHER PROJECT



HELANG TOPSIDES PROJECT



KIKEH DTU TRUSS SPAR PROJECT



KIKEH DTU TRUSS SPAR PROJECT





# Johor



BEBERAPA orang pengkimpal melakukan kerja mengikut kategori dan kemahiran masing-masing di Jurunature, Pasir Gudang, Johor. - UTUSAN/RAJA JAAFRARI

### Jurunature lahirkan lebih ramai jurukimpal berkemahiran tinggi

## Kerja tidak glamor tapi lumayan

utusanjohor@utusan.com.my

**JOHOR BAHRU 10 Mei** - Mungkin ramai yang menganggap kerja sebagai jurukimpal tidak glamor, namun ia sebenarnya memberi pendapatan lumayan kerana tidak ramai yang memiliki kemahiran tersebut.

Menyadari potensi itu, sebuah syarikat bumiputera, Jurunature Sdn. Bhd., bertekad melahirkan lebih ramai pekerja mahir dalam bidang kimpalan gas dan petroleum.

Bagi mengiktiraf profesion tersebut, syarikat berkenaan melancarkan program akreditasi bagi para pekerja baru-baru ini untuk memahut seruan kerajaan bagi melahirkan lebih ramai pekerja mahir dalam sektor berkenaan yang berpendapatan tinggi.

Begitulah Utsmanya, Datuk Seri Muhammad Syafiq Abdullah berkata, pihaknya mengambil langkah proaktif bekerjasama dengan Lembaga Pembangunan Industri Pemukiman (CIDB) melancarkan akreditasi atau ujian kemahiran itu supaya mereka mempunyai nilai tambah dan seterusnya dapat bersaing dalam pasaran tempatan dan antarabangsa.

"Kita mahu menjadi contoh kepada syarikat lain yang menyediakan program akreditasi untuk para pekerja dan yang penting melalui kerjasama strategik ini memberi pendidikan dan membuka mata syarikat binaan untuk memastikan setiap pekerja mendapat perakuan akreditasi CIDB."

"Kita merancang memberi tau-



INILAH kad perakuan bagi seorang jurukimpal bertauliah di Jurunature, Pasir Gudang.

lah kepada 400 lagi kakitangan di syarikat kami secara berperingkat-peringkat, bagi membolehkan mereka terus melangkah jauh bukan sahaja di dalam negara, malah ke peringkat global kerana ia menunjukkan pendapatan lumayan," katanya kepada *Utusan Malaysia* di sini baru-baru ini.

Muhammad Shafiq berkata, tu-

juan syarikatnya mengendalikannya program itu kerana CIDB bakal mewajibkan semua pekerja binaan di negara ini mendapatkan akreditasi atau pentauliahan yang dijanjikan dilaksanakan awal tahun depan bagi semua pekerja binaan tempatan yang mempunyai tahap kemahiran yang menepati Standard Kemahiran Industri Pembangunan Kebangsaan.

Menyerasi program akreditasi itu, pekerja binaan akan menjalani satu ujian praktikal untuk mengesahkan kemahiran yang dimiliki dikraf bagi memenuhi pawaian.

Menurutnya, Jurunature berharap bukan sahaja dapat melahirkan lebih ramai juru kimpal berakreditasi, malah membentuk jurukimpal berkualiti, cekap serta mencapai standard

Jurunature berharap bukan sahaja dapat melahirkan lebih ramai jurukimpal berakreditasi, malah membentuk jurukimpal berkualiti, cekap serta mencapai standard keperluan industri petroleum dan gas yang semakin berkembang.

MUHAMMAD SYAFIQ ABDULLAH Pengarah Urusan Jurunature Sdn. Bhd.



AHMAD ALI

keperluan industri petroleum dan gas yang semakin berkembang. Sementara itu, Pengurus Besar Jurunature, Ahmad Ali berkata, sejak syarikat itu ditubuhkan kan 12 tahun lalu, kira-kira 8,000 jurukimpal terlatih telah dilahirkan pihaknya.

Lebih membanggakan, katanya, sebahagian besar daripada mereka bukan sahaja telah keluar daripada garis kemiskinan, malah kini mampu mendapat pendapatan antara RM3,000 hingga RM6,000 sebulan.

"Kami turut berbangga kerana kira-kira 100 jurukimpal yang telah ditawarkan bekerja di pelantar minyak mendapat gaji RM450 hanya untuk dua jam bekerja sehari," katanya.

### Orang ramai diminta bantu kesan Harmiza

JOHOR BAHRU 10 Mei - Polis meminta kerjasama orang ramai bagi mengesan seorang wanita, Harmiza Haridan, 29, yang dilaporkan hilang dari rumah sejak 10 Mac lalu.

Ketua Polis Daerah Seri Alam, Supritendan Rozlan Zaimuddin berkata, mangsa yang tinggal di Nombu 36, Jalan Angsana 3, Taman Rinting dekat sini, dilaporkan keluar dari rumah untuk menghadiri temu duga kerja di Senai pukul 9.30 pagi dan tidak pulang ke rumah selepas itu.

Justeru, orang ramai yang mempunyai sebarang maklumat mengenai Harmiza boleh menghubungi Ketua Polis Balai Mssai, Inspektor H. Ratuasaban di talian 019-9201020 atau 07-2511232 atau melalui-melalui balai polis berhampiran.

## 'Bidang yang menarik, beri kepuasan'

JOHOR BAHRU 10 Mei - Beberapa jurukimpal mengakui mereka mendapat pendapatan lumayan hasil ilmu dan kemahiran yang dipelajari di Jurunature Sdn. Bhd., di sini.

Selaman Selamat, 50, yang telah menceburi bidang tersebut sejak 28 tahun berkata, jurukimpal memainkan peranan penting untuk menghasilkan pelantar minyak dan gas dan segi pembinaan struktur, pemasangan litar paip serta kerja elektrik dan mekanikal.

"Pada dasarnya kerja mengimpal memerlukan tumpuan dan ketelitian kerana keuntungan syarikat bergantung kepada kemahiran dan kebolehan jurukimpal," katanya.

Dia yang menjadi penyelia di Jurunature kini mengukuhkan bidang kimpalan merupakan bidang yang menarik dan memberi kepuasan kerana mampu memberi pendapatan sehingga RM6,000 sebulan.

Bapa kepada lima anak itu memberitahu, pada mata kasar, kerja kimpalan nampak mudah, namun ia berbahaya terutama kepada kes-



JAMALUDDIN



MOHD. ROSMAN

hatan dan menuntut petugas memakai kelengkapan termasuk perlindungan muka.

Bagi Jamaluddin Shamsuddin, 35, yang sebelum ini menjadi peniaga perisai terarik mendalami kemahiran sebagai pembantu jurukimpal sejak tujuh bulan lalu.

"Mula-mula saya buat yang kecil-kecil dan kemudian ikut senior baru boleh buat struktur yang besar," katanya sambil memberitahu hanya bersekolah hingga tahun

enam dan kini mampu memperoleh pendapatan kira-kira RM3,000 sebulan.

Mohd. Rosman Jumiran, 43, yang hanya berskolah sehingga tingkatan tiga pula memberitahu, minatnya dalam bidang itu berputik apabila melihat ramai rakannya memperoleh pendapatan lumayan sehingga mampu membeli rumah, kereta baru dan menara keperluan keluarga.

"Sebelum menjadi jurukimpal saya terpaksa menjalani ujian dua kali baru lulus, itu pun setelah mendapat tunjuk ajar dan belajar daripada mereka yang lebih mahir.



MEMAKAI topi khas, cermin mata gelap dan menutup muka menjadi aspek keselamatan yang penting bagi seorang jurukimpal di Jurunature.

### Johor

PEJABAT UTUSAN MALAYSIA

JOHOR BAHRU  
T : 07-3332880 / 3332906  
F : 07-3329934

E : utusanjohor@utusan.com.my  
utusanjohor@yahoo.com

MUAR  
T : 06-9548867  
F : 06-9547513

BATUPAHAT  
T : 07-4342143  
F : 07-4318153





## PRODUCT AND SERVICES

### Product and Services Overview

**JURUNATURE** is now recognized as a leading provider of many specialist products and services to the industry. The company is further renowned for quality and production in-line / every time with the client's schedule.

Our range of products and services include:

- Fabrication Works
- Humidur Single Coating System
- HiCO<sub>2</sub> Dry Ice Blasting
- Passive Fire Protection Services
- Jurunature's PFP Casting System
- JuruFlex - J120 - Jet Fire Jacket System
- Fire & Blast Protective Systems
- Fire Rated Doors
- FRP Grating Systems
- Welding Electrodes
- Field Joint Coating Services
- Enertherm Sprayable Insulating Coating
- C-Saddle Pipe Supports
- Topside Robotic Inspection
- Emission Monitoring and Reporting
- Dredging & Land Reclamation, Offshore, Environmental, Infra Marine
- Vegase – Safety Engineering in Gas Detection, Liquid Hydrocarbon
- ProTXcoat – High Temperature Insulation and Repair Coating
- Sacrificial Anodes with Induction Melting Technology
- Recoat Anti-Microbial Protective Coating
- VSAT Systems and ICT Solutions





HIGHEST QUALITY

**FABRICATION**

WORKS







## Fabrication Works



“ *Achievement of 5 Million Safe Manhours* “

EPCIC of KASAWARI Gas Development Project, March 2021



“ *Best Subcontractor* “

BOKOR CPP Phase 3 Redevelopment Project, January 2019

## Highest Quality Fabrication Works

- Structural Fabrication
- Piping & Mechanical
- Electrical & Instrumentation
- Blasting & Painting

**JURUNATURE**'s goal is to provide clients in the fabrication industry the highest quality fabrication in the most timely and efficient manner possible. The number one priority is responsive, personalized service regardless of job size. The company has built an enviable reputation through close client cooperation and the consistent delivery of quality products on time and on budget.

## Responsive, personalized service on the fast track

**JURUNATURE** has extensive experience in fast-track fabrication contracts. The company responds quickly with personalized service. The net result is a company that works closely with its clients to meet the critical requirements of contemporary construction methods.

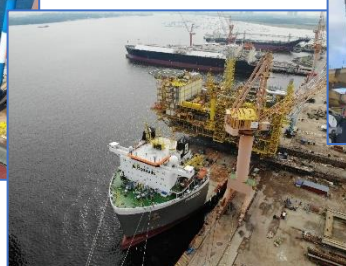



## STRUCTURAL FABRICATIONS

**JURUNATURE**, an ISO certified company has successfully delivered a number of structural fabrication projects. We have a good combination of state-of-the-art equipment and experienced staff of all trades - professionals, skilled and semi-skilled. These include engineers, welders, fitters, riggers, etc. Our complete range of documents/procedures required for project execution ranges from engineering right up to commissioning activities and we are always ready to develop new procedures and WPS to meet project requirements. In terms of production, our welders, for example, are equipped with AWS and ANSI certifications, which results in higher productivity and safer work environment. We are also working very closely with CIDB and TWI in certifying our staff to fulfill the local certification requirement.

As for project management, our experience and dedicated project management personnel are well equipped with the required knowledge for communication. We also have been sending most of its project management personnel to attend various project management courses as well as technical related courses to further enhance the skills of the management team. Dedicated project management team are available for all trades such as Structural Fabrication, Piping Fabrication/Installation, Electrical & Instrumentation Work, Architectural Work, Blasting & Painting and Passive Fire Protection Work, Insulation and HVAC Work, Blastwall & Firewall EPC Projects, Mechanical Installation Work, etc.

Engineering services is part of our capabilities. Its in-house engineering allows us to provide on-time design and drawings. Working closely with the project management team, our in-house Engineering Department has the capabilities to deliver and support the project management team.



***BOKOR CPP Project - Loadout and Sail away (Aug 2020)***





Among the Structural Projects successfully delivered:

- Modec Espadarte FPSO Project - Petrobras, Brazil
- Sumandak B Project - Petronas Carigali Sdn Bhd
- PC4 Gas Development Project - Petronas Carigali Sdn Bhd
- CPOC Jacket - Petronas Carigali Sdn Bhd
- Tangga Barat Development Project - Petronas Carigali Sdn Bhd
- Kumang Cluster Development Project - Petronas Carigali Sdn Bhd
- Tapis R & Q Project - EXXONMOBIL
- Gumusut Kakap East Module (Topside) - MISC
- Gumusut Kakap Hull - MISC
- Process Platform B-193 - ONGC
- EPCIC OF 5 Wellhead Platform B-193 - ONGC
- Damar-A Platform (Topside) - EXXON
- BOKOR CPP Phase 3 Redevelopment Project - Petronas Carigali Sdn Bhd
- Structural, Mechanical and Piping Works for Bergading CPP-MRU - HESS
- KASAWARI Gas Development Project – Petronas Carigali Sdn Bhd (in progress)



*" ..MMHE subcontracted Boskalis for the transportation and float-over installation of a topside for the Bokor CPP in July 2018.*

**JURUNATURE** was contracted as the fabrication partner, while Labuan Shipyards & Engineering was contracted to provide yard services for helideck storage and handling of the Bokor CPP. Paladon Systems supplied 6-in valve actuators for the project in 2018.

*Berachah Group provided FEED and detailed engineering design services for the Bokor Phase-3 redevelopment project.. "*





## PIPING FABRICATIONS

**JURUNATURE** has performed extensive work on riser and pipeline fabrication. We have experienced in most types of piping fabrications, from basic straight spools to highly complex spools for both low-pressure systems and extremely high-pressure applications. We have proven ourselves on the high levels of pipe fabrication and pipefitting abilities which enables us to meet our client requirements.

Some of the Piping Projects that we have successfully delivered to date are:

- PC4 Gas Development Project - Petronas Carigali Sdn Bhd
- Tangga Barat Development Project - Petronas Carigali Sdn Bhd
- Kumang Cluster Development Project - Petronas Carigali Sdn Bhd
- Tapis R & Q Project - EXXONMOBIL
- Process Platform B-193 - ONGC
- E11 P-B – SHELL

## ELECTRICAL & INSTRUMENTATION WORKS

JURUNATURE provides a wide range of electrical & instrumentation engineering services, mainly in the oil and gas sector. Our electrical and instrumentation engineering services include on-site construction activities of electrical installation of electrical equipment and panels, end-to-end testing, calibration and adjustment, pre commissioning, commissioning and providing technical assistance.

Some of the E&I Projects that we have successfully delivered to date are:

- PC4 Gas Development Project - Petronas Carigali Sdn Bhd
- Tangga Barat Development Project - Petronas Carigali Sdn Bhd
- Kumang Cluster Development Project - Petronas Carigali Sdn Bhd
- Tapis R & Q Project - EXXONMOBIL
- Process Platform B-193 - ONGC
- Fabrication & HUC of ANDP-D Platform - RFSB

Apart from the works / projects listed above, we have also managed to deliver the following projects for the following clients:

1. Refurbishment of the JLAY Tower on Board Sapura 3000 Deepsea Pipe Installation Vessel.
2. Fabrication of various Offshore Installation items for Petronas Carigali, Exxon Mobil, Shapadu (SEEN), Talisman, Sabah Shell, Sarawak Shell, Murphy Oil, etc.





*KASAWARI GAS  
Development Project  
– in progress  
(May 2021)*

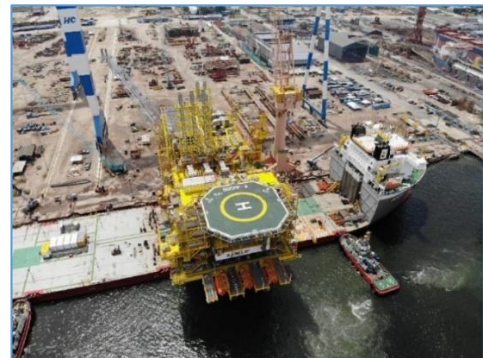

*BOKOR CPP Phase 3 Redevelopment Project  
- Loadout and Sail away (Aug 2020)*



*Structural, Mechanical and Piping Works for HESS Bergading CPP-MRU*





*KUMANG CLUSTER  
Development Project (2008)*



*CPOC MDPP Jacket Project (2008)*



*MELOR LAHO MLDP Project (2008)*



*TANGGA BARAT Project (2008)*



*BOA Project (2007)*



*PC4 Project (2007)*



*SUMANDAK Project (2007)*



*MODEC Project (2005)*





## FABRICATION PROJECT AWARDS AND RECOGNITIONS





**HUMIDUR.**

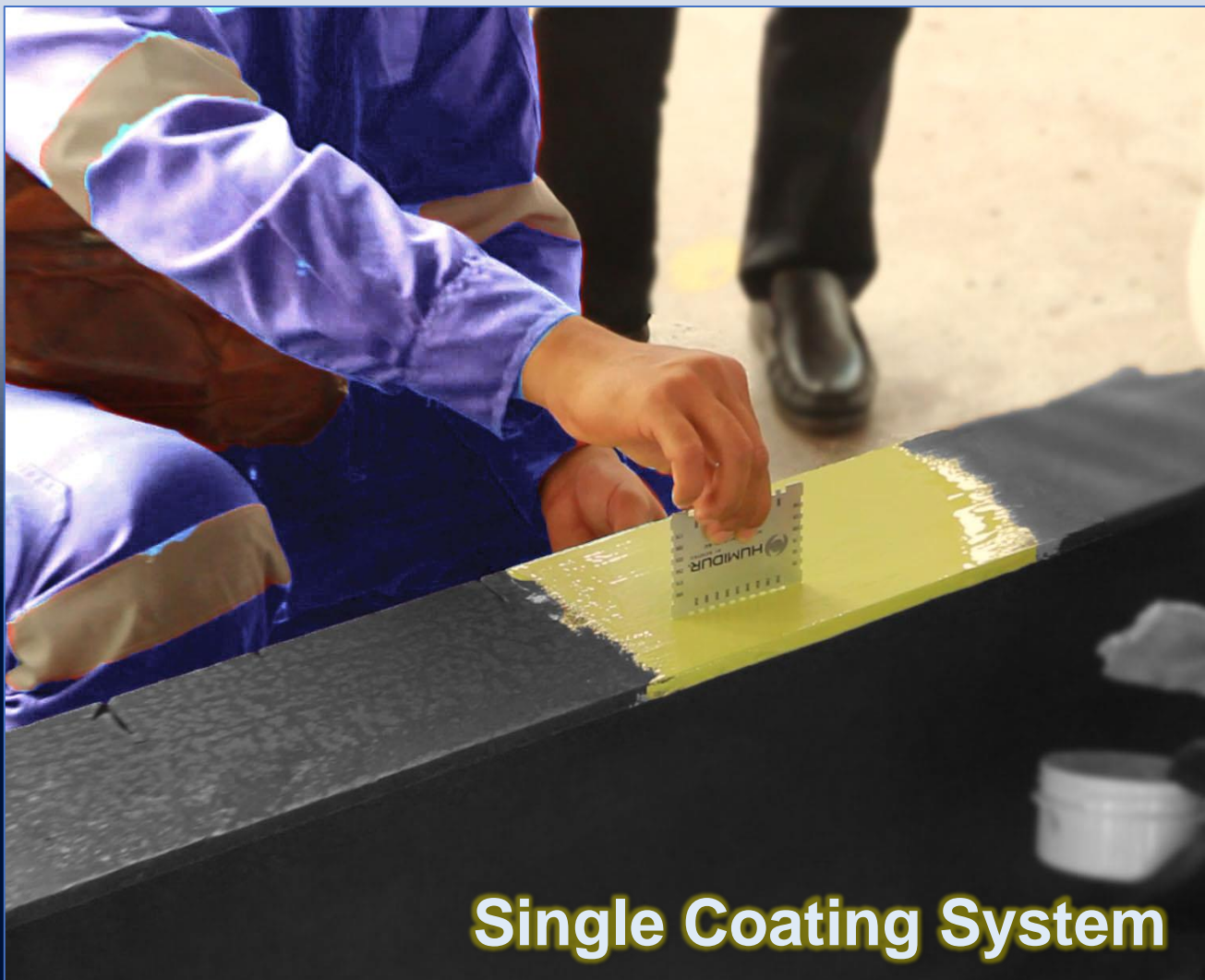

**Single Coating System**







## HUMIDUR® Single Coating System



**HUMIDUR® = HUMIdity + DURability**

**ACOTEC = Anti CORrosion TECHnology**

Humidur® is the brand of protective and marine coatings developed by Acotec. With 30 years of expertise in anti-corrosion coatings, anti-fouling coatings and top coats, Humidur® offers solutions to a wide variety of markets: the offshore oil and gas market, petrochemical industry, shipping, marine industry and energy market.

### Heavy-duty performance and outstanding properties

The system has proven to be maintenance-free when there has been minimal or no mechanical impact.

Humidur® is a system designed to use in all kinds of water and has a high chemical resistance at the same time. The system has proven to be effective in salt, brackish, fresh, drinking and even waste water. It also protects steel tanks and pipes with more aggressive chemicals.

In the marine and shipping industry, the products may also be used in submerged, splash zone and tidal areas and in atmospheric zones. In other words, Humidur® is able to function on the complete structure. This is proven in practice on multiple structures for several decades!

### Five Humidur systems covers most structures

1. Successful in all types of water environment
  - Proven system in salt – brackish – fresh water
  - Officially approved for potable drinking water structures
2. Ideal for structures in water
  - Works in fully submerged zone, tidal / splash zone and atmospheric zone
  - Perfect for pipelines, offshore and marine structures, ballast tanks
3. Increased Flow velocity
  - Smooth surface
  - Perfect in moving water – increase flow velocity, capacity





#### 4. Cures under water

- Immediate use of structure
- Minimum downtime
- Unique efficiency in coating of submerged and splash zones!

#### 5. Single-layer system

- 1 layer built up to the requested DFT
  - No primers required
  - Reduced production and application costs substantially
- 
- User friendly; min surface preparation
  - 30-year claim-free system and satisfied customers worldwide
  - Ideal solution for Sweating Lines and CUI
  - Surface tolerant: even under minimal surface preparation conditions the coating withstands extreme conditions (adhesion values reach up to 25 MPa)

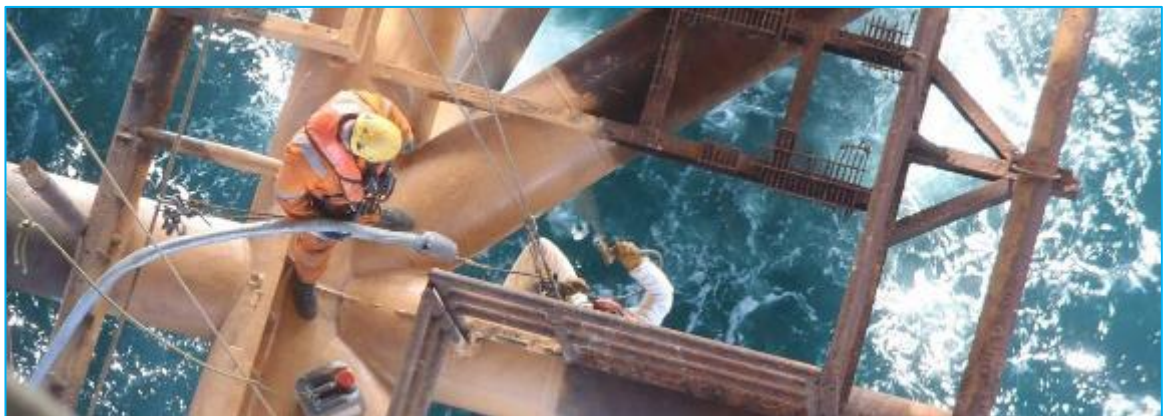



## APPLICATIONS

The manufacturer of Humidur®, Acotec, provides the full service from coating manufacturing, to coating application and quality control in cooperation with its clients. Acotec can provide the full equipment and technical assistance which makes the Humidur® products to the most complete products on the market.

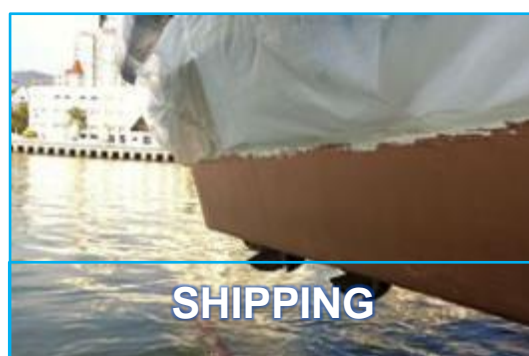



## KEY BENEFITS



### *Cost Effective*

- Single Coat
- Minimal surface preparation and shutdown
- No Primer and Top Coat required
- Allows for NDT inspection at 400µm DFT
- 1/3 losses compared to 3 - layer coating system
- Up to 30 Year Warranty



### *Significant Productivity Increase*

- Up to 40% productivity increase over 3-layer system
- No revisit for 2<sup>nd</sup> and 3<sup>rd</sup> coat application - 1 day application time vs. min 3 days for 3-layer system
- No intermediate curing times for multiple layers
- Cures Underwater



### *Increased Window of Application*

- Can be applied :
  - In high humidity conditions i.e. as high as 95% Humidity
  - Within a temperature Range -35°C to 150°C
  - To pH levels  $0 < \text{pH} < 14$
  - To salt levels  $< 65 \text{ mg/m}^2$



### *Enhanced HSE Management*

- It is environmentally friendly (no VOC's, no coal tar, no heavy metals, no isocyanates)
- Eliminates need for multiple solvents/chemical
- No risk of pollution; solvent free - no heavy metals, coal tar or isocyanates
- No leaching when curing under water
- No HSE risk - 100% VOC free
- Minimum risk of explosion due to higher flash point ( $>100^\circ\text{C}$ )





## Case Studies: HUMIDUR Application at PETRONAS PCOGD, Kertih

**Detail:** HUMIDUR Single Coating Systems Application on Ambient, Hot and Sweaty Pipes

**Client:** PETRONAS PCOGD

**Date:** 12-13 Nov 2019

**Location:** PETRONAS PCOGD, Kertih, Terengganu

### Ambient Pipe with Normal Surface Temperature (less than 50°C)



Before application



Before application



Mechanical preparation to ST2



Mechanical preparation to ST2



Coating applied during normal surface temperature



Coating applied during normal surface temperature





## Pipe with Hot Surface Temperature (60°C - 70°C)



Before application



Before application



Mechanical preparation to ST2



Mechanical preparation to ST2



Coating applied during hot surface temperature



Coating applied during hot surface temperature





## Pipe with Hot Surface Temperature (60°C - 70°C)



Before application



Before application



Mechanical preparation to ST2



Mechanical preparation to ST2



Coating applied during hot surface temperature



Coating applied during hot surface temperature





## Pipe with Cold Surface Temperature (13°C - 25°C)



Before application



Mechanical preparation to ST2



Coating applied during cold surface temperature







## Case Studies: Offshore Platform Onsite Repair

Detail: Corrosion repair and overcoat with Humidur with minimal preparation

Client: Talisman Energy UK Ltd

Applicator: CAN Offshore Ltd

Date: Feb-Mar 2013

Location: Offshore UK, North Sea





## Case Studies: Offshore Platform Nodes Repair

Detail: Coating repairs of nodes by rope-access

Client: Talisman Energy UK Ltd

Applicator: Stork Technical Services

Date: Sep-Oct 2014

Location: Offshore UK, North Sea





## Case Studies: Offshore Platform Repairs

Detail: Coating repairs of assets

Client: Shell Sarawak

Applicator: Jurunature and Dayang team

Date: 2015

Location: Offshore platform, Malaysia water





## Case Studies: Offshore Platform Repairs

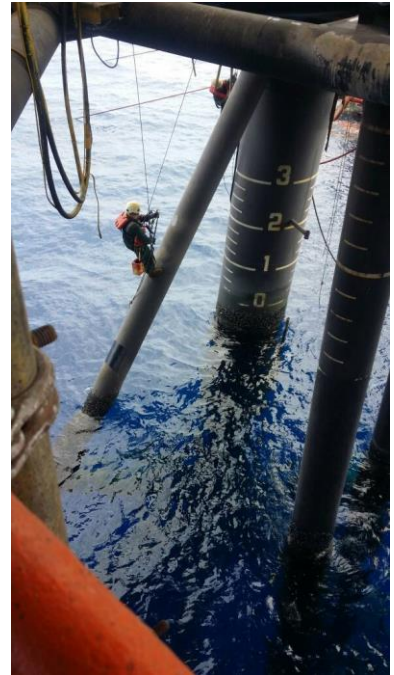



## PETRONAS Approval Letter – August 2018



*Our Reference:* ENGG/MCI/CORRES/10.08/2018/03

*Your Reference:* JNSB/PPCTC-HMDR/0308/2018

6<sup>th</sup> August 2018

JURUNATURE SDN BHD (480488-P)  
Suite 4-07, Level 4 AMODA Building,  
22 Jalan Imbi,  
55100 Kuala Lumpur.  
Attn: Dato' Sri Muhammad Syafiq

Dear Sir,

**Re-APPLICATION FOR HUMIDUR SINGLE COATING SYSTEM FOR STANDARD COATING TESTING WAIVER AND BE LISTED UNDER PETRONAS APPROVED LIST**

We are pleased to inform you that PETRONAS Protective Coating Technical Committee (PPCTC) is hereby confirmed that we had carried out technical assessment for 'Humidur Single Coating System' by JURUNATURE SDN. BHD. In-lieu of coating standard testing procedure as per PTS 15.20.30 Protective Coatings and Linings.

The Humidur Single Coating System is now APPROVED for usage at PETRONAS facilities and its subsidiaries with immediate effect until a period of 5 years from the date of this letter. Asset owner is advised to discuss detail on products specification, application, warranty term and limitations prior using it with the vendor.

List of Humidur Single Coating System are as following:-

1. Humidur ME (Modified Epoxy)
2. Humidur FP (Full Protection)
3. Humidur TC (Top Coat)
4. Humidur AF (Anti Fouling)

Above products will be listed under PETRONAS Approved Protective Coating Master List.

Internal  
**PETROLIAM NASIONAL BERHAD (PETRONAS)** (20076-K)  
Tower 1, PETRONAS Twin Towers, Kuala Lumpur City Centre, 50088 Kuala Lumpur, Malaysia  
T: +(603) 2026 5000, 2051 5000 F: +(603) 2026 5050  
[www.petronas.com](http://www.petronas.com)





## PETRONAS Approval Letter – August 2018



Page 2 of 2

Followings are the conditions that read together with this approval;

- a) *PETRONAS reserves the right to partially or completely withdraw any approval given to the vendor should there is any technical discrepancies found with their product and/or services.*
- b) *PETRONAS and its subsidiaries have the right to request for full reimbursement to the vendor on any expenses incurred as a result of product and/or service discrepancies that affected the quality of the painting work.*
- c) *The vendor shall provide their utmost product quality and workmanship to ensure best performance rendered for their work and product.*
- d) *At any time or condition, PETRONAS may randomly request the vendor to submit their product for quality testing to accredited third party laboratory e.g. SIRIM Shah Alam to ensure the supplied products to the market are sustainably meeting the product specifications and compliance to PETRONAS requirement. The cost of the testing shall be borne by the vendor.*
- e) *Product application must be compliance to PTS 15.20.03 Protective Coating and Linings*

We are looking forward to your active participation in our energy business.

Thank you,

Yours sincerely,

For **PETROLIAM NASIONAL BERHAD (PETRONAS)**

**Muhammad Hawari bin Hasan**

Chairman for PETRONAS Protective Coating Technical Committee (PPCTC)  
Group Technical Solutions  
Materials, Corrosion and Inspection (MCI)  
Infrastructure, Engineering Department  
Group Technical Solutions  
Project Delivery & Technology  
PETRONAS

Internal  
**PETROLIAM NASIONAL BERHAD (PETRONAS)** (20076-K)  
Tower 1, PETRONAS Twin Towers, Kuala Lumpur City Centre, 50088 Kuala Lumpur, Malaysia  
T: +(603) 2026 5000, 2051 5000 F: +(603) 2026 5050  
[www.petronas.com](http://www.petronas.com)





## Product Approval @Shell

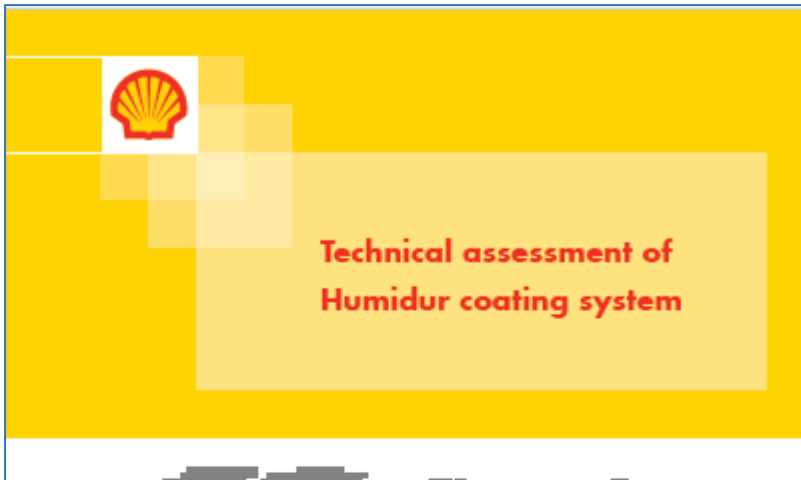

Received fast-tracked SHELL Global approval in May 2016 and currently undergoing Global roll-out for all its facilities & plants.

### Executive summary

Within Shell assets and projects there is a tendency to use alternative coating systems compared to the conventional primer/epoxy midcoat/UV resistant topcoat coating system for atmospheric conditions, especially for maintenance purposes for offshore applications.

One of the options is a maintenance coating system, the Humidur coating system, manufactured by Acotec, Belgium. The Humidur coating product is a single layer surface tolerant 2-component solvent-free modified epoxy coating.

It is the intention to extend the use of this optional maintenance coating system to Shell assets globally. This report describes the technical assessment of the Humidur coating system based on manufacturer information, Shell assets experiences, other track records and (third) laboratory test reports.

It was concluded that Humidur FP can be approved to be used within Shell assets and projects for Sa2½ blasted steel and provisional for St2 and St3 prepared steel surfaces.

Restricted  
SR.16.11493  
May 2016





## Product Approval @Aramco



### Qualification testing of Humidur FP Single for approval to APCS-19C, 09-SAMSS-70

Carried out by INTERTEK  
On behalf of SAUDI-ARAMCO

#### Conclusion

Humidur was approved by Saudi Aramco for use on offshore assets after successfully completing this test program.

This program is far more severe version of the Norsok test program and is especially harsh for polyamine cured epoxy systems such as Humidur as the temperatures are extremely high. Traditional epoxy systems are usually limited to an operating temperature of maximum 60°C in water. Humidur easily passed the cathodic disbondment test at 80°C. In the Norsok test program this test is performed at a temperature of only 23°C.

Moreover, the coating resistance before and after the ageing resistance and seawater immersion was quantified by means of Electrochemical Impedance Spectroscopy. The acceptance criterion was  $> 10^8$  ohm.cm<sup>2</sup>. Humidur passed every test with more than  $> 10^{11}$  ohm.cm<sup>2</sup>.

Acotec nv

Industriëlelaan 8

T: +32 53 83 86 60

01/02/2017

Zuid 88

F: +32 53 83 89 88

9120 Irenbodwegen (Aalst)

M: info@acotec.be







HiCO<sub>2</sub>

# DRY-ICE Blasting





## HiCO<sub>2</sub> Dry Ice Blasting



Most innovative technology that uses high-density CO<sub>2</sub> as a form of blast medium, which eliminates the need for extraction, waste removal, and encapsulation. The process also offers you the opportunity to blast and paint at the same time. Used for removal of heavy corrosion, epoxy coatings, PFP coatings and hard scales and is the world's first corrosion removal system using dry ice. The world's first mobile high-density dry ice production system and are pioneers in offshore dry ice blasting projects. Significant savings due to the reduction of site preparation, clean-up costs and waste disposal costs as there is no waste as the ice evaporates. Significant time saving as it takes on 25% of the total time compared to traditional methods (eg. Grit blasting).

### SURFACE PREPARATION

Recent tests have achieved the following results, following blasting with our system:

- Cleanliness inspection – in line with SA2.5 standard
- Profile reading – 70 microns after blasting Cat D corroded surface
- Salt readings – 0 after blasting the above
- Adhesion tests – readings of 15-27MPa achieved on the above surface after recoating

### Generating a new surface profile

DI Global carried out TSA testing with the Shell TRT department.

Tests past which proved the DIG MM system is capable of producing a surface cleanliness & sufficient profiles to pass TSA adhesion and bend tests.





Technology achieves significant savings due to the reduction of site preparation, clean-up costs and waste disposal costs.

## SAFETY AND ENVIRONMENT

Technology is safe to use, with reduced hazards to the operator and surrounding environment. The CO<sub>2</sub> we use comes from recycled sources.

## TRACK RECORD

Our client list includes the following:

- Shell, Total, Valero, Nexen, EnQuest and Brunei LNG

## CASE STUDY

The table below documents a recent case study and the savings that were achieved. The time savings were realised through the lack of encapsulation and clean-up, completing the scope in just under 25% of the time for traditional methods.

Activity	Grit Blasting	DIGMM System	Time Saving
Encapsulation	4.5 hours	0.2 hours	4.3 hours
Blasting	2 hours	2 hours	0 hours
Clean Up	2 hours	0 hours	2 hours
Total	8.5 hours	2.2 hours	6.3 hours





## Comparison Between Conventional and HiCO<sub>2</sub> Dry Ice Blasting

Grit blasting vs Dry ice blasting



- ❑ Time taken to tape up stainless steel and encapsulate first half:
  - 1 hour 30mins for x 3 man
- ❑ Time taken to blast the first half:
  - 2 hours of trigger time x 1 man
- ❑ 27 bags of garnet
- ❑ 675 kgs of garnet
- ❑ Clean up all of Garnet:
  - 1hour x 2 man
- ❑ Total Man hours for first half set-up, blast, clean up:

8hours 30 mins



- ❑ Time taken to tape up stainless steel and encapsulate FULL works:
  - 10mins x 1 man
- ❑ Time taken to blast the FULL works
  - 1 hour of trigger time x 2 man
  - 10 mins of Bristle blast x 1 man
- ❑ 100kg of Dry Ice
- ❑ Clean up
  - N/A
- ❑ Total Man hours for FULL works set-up, blast clean up:

2 hours 20mins





## Comparison Between Conventional and HiCO<sub>2</sub> Dry Ice Blasting (con't)

Grit blasting

vs

Dry ice blasting





## REMOTE PRODUCTION

HiCO<sub>2</sub> Dry Ice production units are fitted with the latest in dry ice production technology. Various sizes and capacities can be accommodated. Our standard equipment is delivered in a 10ft shipping container.





## SUMMARY

### *Expertise:*

- ✓ **Dry Ice Blasting** technology (either **HiCO<sub>2</sub> alone** OR with **MM** under high air pressure to remove various contaminants)
- ✓ Pioneer in **offshore dry ice blasting** projects
  - The revolutionary, patented technology has been developed specifically for **surface preparation and fabric maintenance purposes** in the Oil & Gas industry, and similar applications
- ✓ World's first **heavy corrosion removal technology** using dry ice
- ✓ Removal of **epoxy coatings, PFP coatings & hard scales**
- ✓ **No salt residue** (eliminate premature coating failure)
- ✓ World's first **mobile high-density production system**
- ✓ The technology achieves **surface preparation** in line with international coating standards, and has been **approved by major coating suppliers**.
- ✓ Equipment is **ATEX Certified** for use in **Zone 1** environments.

### *Ultimately:*

**Reduce cost, improve efficiency & minimise waste (30-50% savings in blasting costs, 50% increase in productivity)**





## PETRONAS Approval Letter – May 2018



Our Reference: ENGG/MCI/CORRES/10.08/2018/02

31<sup>st</sup> May 2018

JURUNATURE SDN BHD (480488-P)  
Suite 4-07, Level 4 AMODA,  
22 Jalan Imbi,  
55100 Kuala Lumpur.  
Attn: Dato' Sri Muhammad Syafiq

Dear Sir,

### **DRY ICE BLASTING WITH ABRASIVE BY JURUNATURE SBN. BHD.**

We are pleased to inform you that PETRONAS Protective Coating Technical Committee (PPCTC) is hereby confirmed that we had carried out technical assessment in terms of performance testing for 'Dry Ice Blasting with Abrasive Technique' by JURUNATURE and its principal according to PTS 15.20.03 Protective Coating and Lining requirement.

The Dry Ice Blasting with Abrasive Technique is now APPROVED for usage at PETRONAS facilities and its subsidiaries with immediate effect until a period of 5 years from the date of this letter.

The blasting technique will be listed under PETRONAS Approved Blasting Technique Master List.

Followings are the conditions that read together with this approval;

- a) *PETRONAS reserves the right to partially or completely withdraw any approval given to the vendor should there is any technical discrepancies found with their services.*
- b) *PETRONAS and its subsidiaries have the right to request for full reimbursement to the vendor on any expenses incurred as a result of service discrepancies that affected the quality of surface preparation for the painting work.*
- c) *The vendor shall provide their utmost workmanship to ensure highest quality and performance rendered for their work.*

Internal  
**PETROLIAM NASIONAL BERHAD (PETRONAS)** <sup>(20076-K)</sup>  
Tower 1, PETRONAS Twin Towers, Kuala Lumpur City Centre, 50088 Kuala Lumpur, Malaysia  
T: +(603) 2026 5000, 2051 5000 F: +(603) 2026 5050  
[www.petronas.com](http://www.petronas.com)







## PETRONAS Approval Letter – May 2018



Page 2 of 2

We are looking forward to your active participation in our energy business.

Thank you,

Yours sincerely,

For **PETROLIAM NASIONAL BERHAD (PETRONAS)**

**Muhammad Hawari bin Hasan**

Chairman for PETRONAS Protective Coating Technical Committee  
Group Technical Solutions  
Materials, Corrosion and Inspection (MCI)  
Infrastructure, Engineering Department  
Group Technical Solutions  
Project Delivery & Technology  
PETRONAS

### C.C

Head  
Infrastructure, Engineering  
Group Technical Solutions  
Project Delivery & Technology

Head  
Material, Corrosion and Inspection  
Engineering  
Group Technical Solutions  
Project Delivery & Technology

Custodian (Inspection)  
Material, Corrosion and Inspection  
Engineering  
Group Technical Solutions  
Project Delivery & Technology

Internal

**PETROLIAM NASIONAL BERHAD (PETRONAS)** (20076-K)

Tower 1, PETRONAS Twin Towers, Kuala Lumpur City Centre, 50088 Kuala Lumpur, Malaysia

T: +(603) 2026 5000, 2051 5000 F: +(603) 2026 5050

[www.petronas.com](http://www.petronas.com)





## SHELL Technical Assessment – Nov 2016



### Technical Assessment of Dry Ice Blasting as surface preparation method for cleaning of steel surfaces and removal of coatings

SR.16.12846

- II -

Restricted

#### Executive summary

Within Shell assets, there is a tendency to source alternative methods for surface preparation in order to save costs and increase productivity. The common used surface preparation method is abrasive grit blasting which uses compressed air or water to direct a high velocity stream of an abrasive material to clean an object or surface and to prepare it for the application of a coating.

As part of their Fabric Maintenance campaign, Shell Corrib has been looking into other means of surface preparation that could help reducing the optional safety hazard while increasing productivity. They have sourced a new method called Dry Ice Blasting.

As part of the Technology Replication Trust (TRT) third party technology program, the Dry Ice Blasting method was identified as a technology with great potential. To provide global technical approval of this technology, Shell PTE was invited to witness the Dry Ice Blasting process at the Corrib site and evaluate this technology.

Based on the documentation and test trials, Dry Ice Blasting is technically approved as surface preparation method to remove coating layers and corrosion scales to be used for Shell projects and assets.

Restricted

SR.16.12846

November 2016





- **Passive Fire Protection Services**
- **Jurunature's PFP Casting System**
- **JuruFlex - J120 - Jet Fire Jacket System**
- **Fire & Blast Protective Systems**
- **Fire Rated Doors**
- **FRP Grating Systems**
- **Welding Electrodes**
- **Field Joint Coating Services**
- **Enertherm Sprayable Insulating Coating**
- **C-Saddle Pipe Supports**
- **Topside Robotic Inspection**
- **Emission Monitoring and Reporting**
- **Fabrication Works**
- **Dredging & Land Reclamation, Offshore, Environmental, Infra Marine**
- **Vegase – Safety Engineering in Gas Detection, Liquid Hydrocarbon**
- **ProTXcoat – High Temperature Insulation and Repair Coating**
- **Sacrificial Anodes with Induction Melting Technology**
- **VSAT Systems and ICT Solutions**





## Passive Fire Protection



A cornerstone of **JURUNATURE**'s business is Passive Fire Protection Services (PFP). **JURUNATURE** have developed to become the leading contractor in Malaysia for the supply and application of Epoxy Passive Fire Protection systems. **JURUNATURE** have developed a strong relationship with Jotun, who are one of the world's leading manufacturers of paints, coating and powder coatings, and who have introduced the next generation of epoxy passive fire protection, which offers considerable benefit to the industry.

Jotun introduces Jotachar JF750, the industry's first mesh free next generation solution for hydrocarbon and jet fires. Jotachar JF750 incorporates an advanced fibre matrix, eliminating the need for complex mesh reinforcement. When exposed to a fire, Jotachar JF750 produces a robust and temperature stable insulating char whilst risks associated with incorrect mesh installation are eliminated.

Jotachar's mesh free solution provides significant benefits for owners, fabricators and applicators compared to systems that require mesh reinforcement:

- Increased productivity
- Installation time reduced with up to 50%
- Maintenance cost reduced
- Saves material costs with up to 50%
- Less risk
- Potential one-coat system for 30 or 60 minute jet fire scenarios

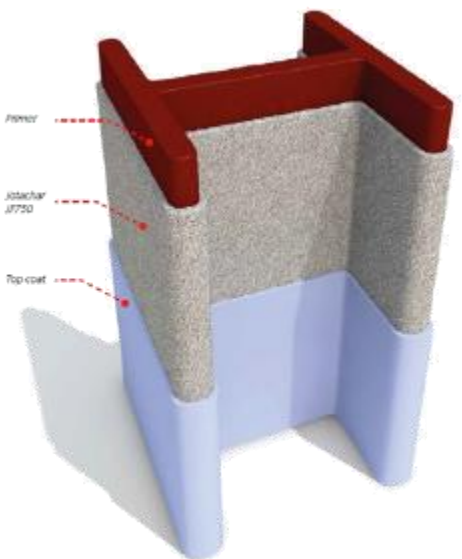
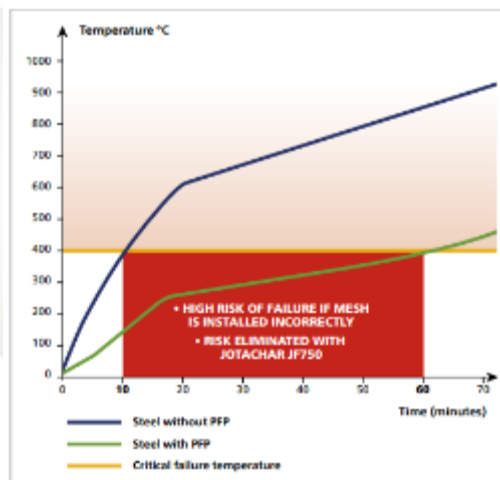



## JURUNATURE's PFP Casting System

### **PROCAST** PFP Casting systems. **(Jurunature's own and manufactured)**

For items requiring maintenance, such as valve or flange; removable PFP casting is used. The protection rating provided is determined by the thickness of the PFP application, plus the thickness and type of material it is covering. The PFP thickness is also determined by the fire protection rating requirements of the client.

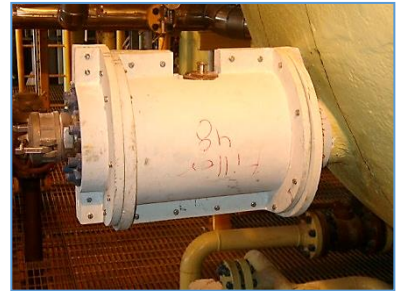

A foam cut-out for trial fitting to a flange



Valve casting sealed to the quick release connector's flange, to allow uninterrupted access to the quick release connector.



Completed 36" Main SDV, installed and fitted with its **PFP** castings and wet applied **PFP**.



SDV after wet application and all but the flange castings are completed. The flange covers were to be fitted offshore, after installation of the valve.



Valve body after wet application. Note, the nameplate and data plate have been left uncovered. They were later covered by removable PFP access panels.





# PFP Casting syste - Installed offshore Peninsular Malaysia

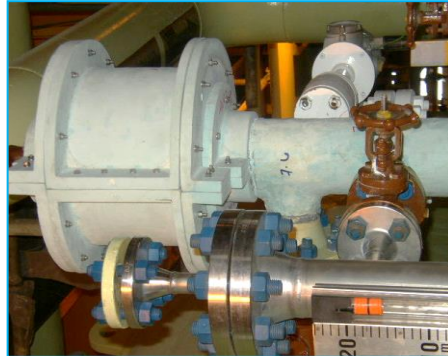
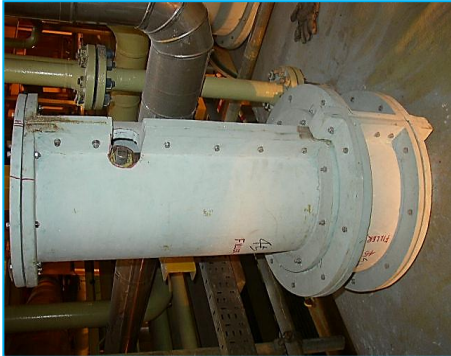



## JuruFlex - J120 - Jet Fire Jacket System

### JuruFlex-120

A Modern, Wire Free, Easy to Install,  
Jet Fire Jacket System

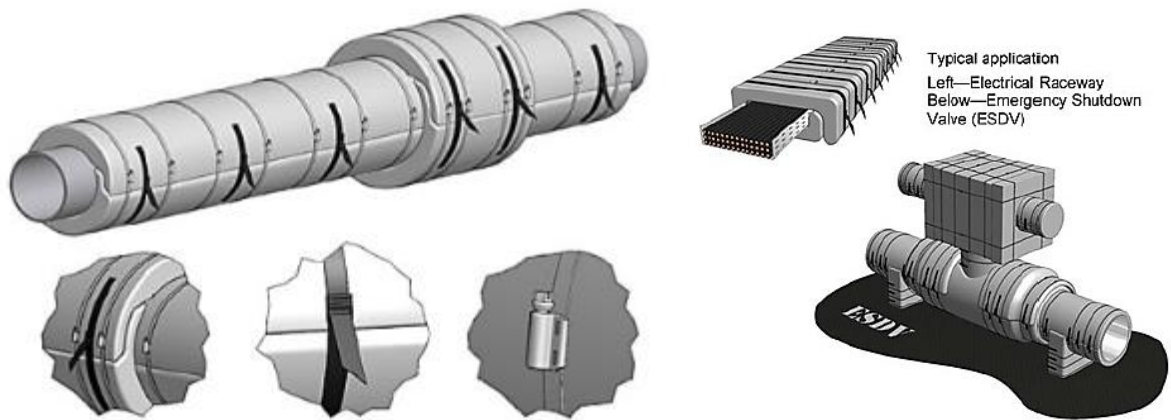

Typical application  
Left—Electrical Raceway  
Below—Emergency Shutdown  
Valve (ESDV)

**JuruFlex-J120** Jet Fire Jacket System, which offers a modern, wire free, easy to install alternative to industry requirements.

The effects of hydrocarbon fires within the oil & gas industries both on and offshore can be catastrophic and can result in major loss of life and capital investment.

**JuruFlex-J120** passive fire protection is a best of breed flexible protection jacket system with quilted construction to facilitate complex structural shapes.

**JuruFlex-J120** is designed for rapid installation using the **JURUNATURE** safe-locking securing system and is fully removable and re-installable for inspection and maintenance.

**JuruFlex-J120** is a certified system, tested to the new and more onerous jet fire standard ISO 2289921 ("Determination of the resistance to jet fires of passive fire protection materials").

**JuruFlex-J120** can be installed around critical plant shutdown equipment such as valves and actuators, pipes and associated equipment, electrical raceways, junction boxes and vessels.

#### Advantages of **JuruFlex-120**

- Simple to install and remove
- Inspection hatches can be incorporated
- Asbestos free
- Manufactured using non RCF fibre
- All testing witnessed & certified by Lloyd's Register
- J120 certified
- NO lacing wire

#### Typical **JuruFlex-120** applicators

- Valves & Actuators (ESDVs, MOVs etc)
- Vessels
- Pipework & Flanged Joints
- Electrical Raceways (cable trays & conduits)
- Junction Boxes





## Fire & Blast Protective Systems



Mech-Tool Engineering Ltd [MTE] is the leading global supplier of solutions protecting people and equipment from fire, blast and radiant heat hazards for the offshore and onshore oil and gas, nuclear, renewable energy, chemical and petrochemical industries.



### **JURUNATURE**

provide Fire & Blast Wall solutions and were the first to fabricate outside MTE premises for Kumang under the supervision of MTE.

**Blast Walls** are high integrity fully welded gas tight systems manufactured from profiled steel and insulated to achieve the specified fire ratings. They are resistant to overpressures in excess of 7 barg and have been designed and supplied with fire ratings of up to H120 and 60 minute jet fire, type approved by Lloyd's Register. We have performed well over 100 full scale blast tests to prove the validity of the fire wall design procedure.

**Blast Relief Systems** are tailored to the individual requirements of each project, taking varying aspects of the specification into account to offer the optimum solution.

**Fire Walls** are high integrity, fully welded gas tight systems manufactured from profiled steel and insulated to achieve specified fire ratings up to H120 and 60 minute jet fire, which are type approved by Lloyds Register. Lightweight prefabricated walls are designed to achieve the most cost-effective and efficient solution to the specified hazard. To prove the validity of the fire wall design procedure we have performed well in excess of 100 full scale fire tests. For simplicity of installation they require no intermediate support steel, whatever the span; and being stainless steel they are maintenance-free.







## Fire Rated Doors



Since 1975, Rapp Bomek delivered more than 35,000 doors to oil and gas installations, ships and other projects to Norway • Australia • Brazil • Canada • China • Europe • Korea • Middle East • Russia • Southeast Asia • West Africa • USA

Rapp Bomek designs and manufactures full range of project specific doors:

- **manual-, pneumatic- and electric operated** sliding doors to meet the requirements in SOLAS 74 and IMO FTP code and according to NORSOK standard C-002: M1, M2 and H1.
- Sliding doors product range: NR, A0, A60, H0, H60 and H120.
- **Hinged and sliding, Single and double, Light-duty** A-0/A-60 rated, Super light-duty A0/A60 rated, **Medium-duty** A-0/A-60 rated, **Heavy-duty** A-0/H-120 rated, **Combination doors, fire rated and weather/watertight**, Non-rated, Louvered, Pneumatically operated, Hydraulically operated and Electrically operated



### Service and maintenance

- Professional service team of more than 20 highly trained service engineers who can provide installation and maintenance on all types of fire doors and systems/equipment.
- Extensive experience, and the necessary certificates and safety courses required for offshore work and have performed installations, surveys, maintenance and recommendations for upgrading and cost effective improvements
- Developed a "Total Agreement" concept, utilized by many platforms and FPSOs in order to reduce costs for the platform operators with long-term frame agreements with several oil companies for maintenance on fire doors and fire door systems.





## FRP Grating Systems



### WE ARE COMMITTED TO QUALITY

When traditional building materials such as wood, steel and aluminum fail to solve your design problems, discover the endless possibilities of STRUCTURAL FIBERGLASS. D.E.F.I. offers the best in FRP Grating Systems. With our large inventories, we are able to provide quick shipments.

Our products are suited for most all industries: Subsea applications, municipal applications, industrial applications, water park applications, as well as decorative applications where strength in the product is a must. View our projects for more information on what we can do.

We will offer you practical alternatives and high-performance composite profiles. We know that traditional materials rot and corrode over time, however, our materials are non-conductive, corrosion resistant, light weight and very versatile.

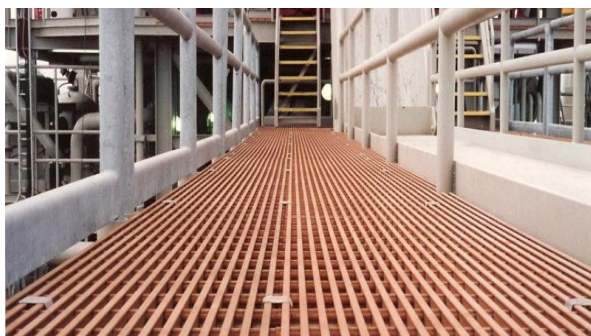



## Welding Electrodes

# KOBELCO



- **Welding Consumables**
- **Tube, Pipe and Pipe Fittings**
- **Heat Exchanger and Tube Bundles**

The welding company has been the leading manufacturer of high quality welding consumables in Japan for over 50 years. Today with 10 manufacturing and sales bases in Asia, Europe, and the United States, Kobelco are meeting the welding needs of industries throughout the world. Kobelco manufacture welding robots, power sources and equipment which are marked individually or packaged with welding consumables as complete systems. Kobelco's cornerstone of operations is the QTQ promise "Quality products, Technical support, Quick delivery".





## Field Joint Coatings



In the area of Field Joint Coating, **JURUNATURE** continues to provide best in class service to the industry and through its partnership with RAE Energy, we strive to offer innovative solutions that ensure the Field Joint Coating application remains off the critical path of pipe laying.

### Concrete Weight Coating (CWC) Infill Applications

- Mechanical Protection
- Anti-Corrosion Applications
  - Fusion Bonded Epoxy
  - Liquid Epoxy
- Three Layer Polypropylene (3LPP) Application
- Serviwrap Anti Corrosion
- Cold Applied Tape System

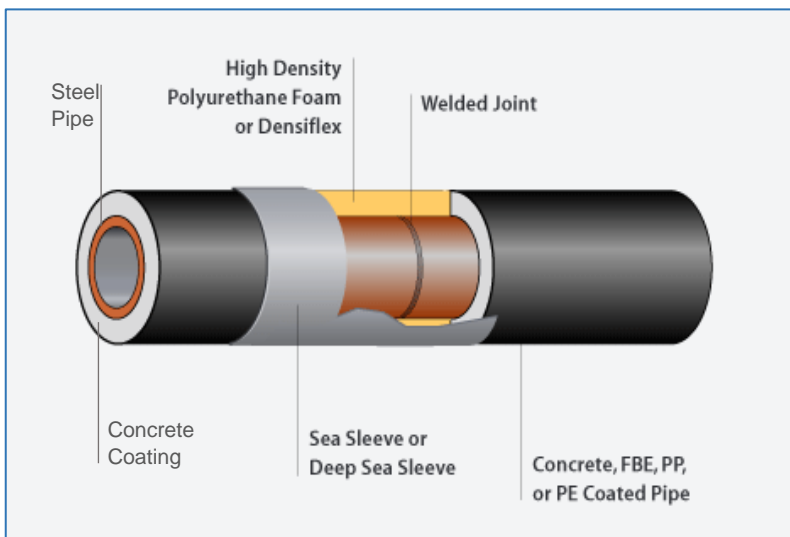



## Enerthem Sprayable Insulating Coating



**Ti220 Performance and Specification**  
 EnerTherm Ti220 was designed in response to all the restrictions of other Thermal Insulation coating on the market.

Ti220 is a water borne system that can be spray applied to film thickness of up to 6mm in a single coat. The material has a temperature range of **-90°C to +220° C**



Foam Structure



Water beads at surface



Can be bent and return to its original shape



Multi-Layered



Large thickness can be obtained without cracking



Advanced Sprayable Insulating Coating

Very Low thermal conductivity

Low Overall Heat Transfer Coefficient

Thermal Diffusivity Hygrophobic/Waterborne

Elastomeric

Volumetric Capacity

No Discolouration

EnoTherm Ti220 has Hygrophobic properties ideal for use as part of a system for the protection of steel against **Corrosion Under Insulation (CUI)**.

Large Industrial oven. Project time line 3 days.  
**14% energy savings**

Before

After

Large Incinerator, Heat Exchanger, and fryer system (180m<sup>2</sup>). Project timeline in 3 days.  
**7% energy savings**

Before

After





## C-Saddle Pipe Supports

# C-SADDLE™

### A LOW-FRICTION NON-CORROSIVE WEAR PAD SYSTEM



### ***C-SADDLES*** ARE THE NEXT GENERATION PROTECTION BETWEEN THE PIPE AND PIPE SUPPORT THAT STOPS DANGEROUS CREVICE CORROSION

C-Saddle uses a flat sliding surface between the saddle and pipe support - the next generation of pipe/support protection. Numerous advantages of product, including ease of installation, no hot work requirements and providing a long-term maintenance free solution.

C-Saddle utilize a non-corroding Fiberglass Reinforced Pipe (FRP) support base that holds the specially designed non-corroding Nylatron NSM Bearing Pad in place. Major Advantages of the C-Saddle System are;

- C-Saddle, with its peel and stick feature, takes less than a minute to install and requires no mixing, special tools or training. Minimum pipe preparation is required.
- C-Saddle utilize a very high bond strength adhesive along with Nylatron NSM Bearing Pad that will keep the C-Saddle firmly secured to the pipe, when overcoming the friction between the pipe and pipe support associated with pipe movement.
- Most traditional "insulators" because of their design create excessively high point loads between the pipe and the pipe support. In most cases the point loads created have PSI's that exceed the yield strength of the insulating materials. The flat surface of the C-Saddle's Nylatron NSM Bearing Pad increases the loading area on the pipe support. PSI loadings can be reduced over 90% extending the life of the C-Saddle.
- The flat surfaces of the Nylatron NSM Bearing Pad on the C-Saddle will keep the C-Saddle firmly in place in the high vibration areas. C-Saddle will not walk out from under your pipe.





## Topside Robotic Inspection



### CAPABILITIES

- Independent Robotically Inspections
- ISO 9001:2008 and VCA approved
- Certified inspectors and high-tech equipment
- Real-time followed from ground level
- Minimize downtime during shutdowns
- Safe, time efficient and cost effective

### Robots

- Small, remote-controlled, lightweight
- Climb tank walls, ceilings, and pipe
- Excellent for cylindrical objects and uneven or flat surfaces
- Interchangeable equipment



RISQ robotics performs independent inspections for e.g. the following industries:

- Oil, gas and chemical industries
- Power plants
- Wind farms on and offshore
- Maritime
- Defense facilities, navy





## Emission Monitoring and Reporting

### Perfect Point Measuring



### Perfect Point Measuring

- First operations in 1996
- Experts in emission monitoring

### Services

- Leak detection (LDAR), SLDAR and flare emission monitoring
- Loss analyses and improvement service
- Asset and Drawings Management Solution
- Energy projects

### LDAR

- Leak Detection And Repair (Reporting)
- To control and to reduce fugitive emissions
- Measurements with TVA and Gasfindcamera
- Point by point measuring



### SLDAR

- Smart Leak Detection And Repair (Reporting)
- Detect emissions with FLIR (GF320) to find leaks and then measure with TVA Tool.
- SLDAR is more quicker than regular LDAR measurement so it's more cost efficient.

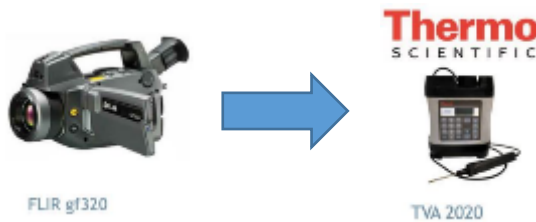

### Converting to TPD

Convert drawings to TPD Software and capture leak data for reporting and repair order.

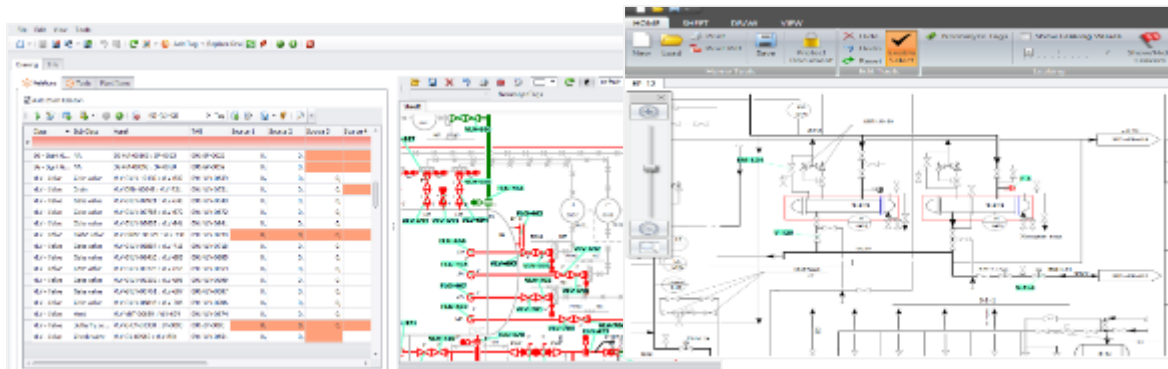





## Dredging & Land Reclamation, Offshore, Environmental, Infra Marine



**JURUNATURE** is committed to conducting its business in a way that minimizes adverse impact on the environment thus we are proud to introduce our partner DEME which is a world leader in the highly specialized fields of dredging, marine engineering and environmental remediation. The Group can build on more than 140 years of know-how and experience and has fostered a pioneering approach throughout its history, being a front runner in innovation and new technologies.

Although DEME's activities originated with its core dredging business, the portfolio diversified substantially over the decades. Today's activities encompass dredging, land reclamation, hydraulic engineering, services for the offshore oil & gas and renewable energy industries and environmental works.

### Dredging & Land Reclamation

Dredging and land reclamation are more than just DEME's core activities. They are at the very foundation of the company. DEME is involved in huge, complex dredging and land reclamation projects worldwide, offering customers cutting-edge solutions. Over the past decades, DEME has executed major marine engineering infrastructure works such as the development of new ports, waterways, airports, artificial islands, residential and recreational areas, industrial areas, roads, bridges etc. on all continents.

#### i. Maintenance Dredging

Maintenance dredging requires a lot of knowledge about the dynamics of an estuary, and even more experience on how to deal with tides, currents, flood channels, bars, bends, and the various nature of suspended material. It is carried out with respect for the environment, reducing overflow and limiting turbidity.



#### ii. Coastal Protection

Coastal protection provides defense against flooding and erosion, caused by waves and tides, winds, currents and littoral drift. Sea level rising, global climate change and melting of the ice caps will increase the need for coastal defense.





### iii. Port Construction

DEME has a vast experience in port construction. It involves often a multidisciplinary approach. Preliminary soil investigation, surveys, nautical studies, and environmental assessments are necessary. Dikes, breakwaters, and underwater bunds provide protected berthing.



### iv. Capital Dredging

Capital dredging is carried out in a perspective of sustainable development, aiming for the long term and with respect for nature. Often, it is executed in sensitive estuaries with proper dynamics and valuable marine life. Often, it is executed in sensitive estuaries with proper dynamics and valuable marine life.



### v. Beach Nourishment

Beach nourishment is a soft alternative to hard coastal defenses and protects against flooding and erosion by dissipating the wave energy. Moreover, it creates an environment for developing tourism and related services. It is executed with natural elements and allows for a dynamic approach by working with the nature. Beach nourishment restores the natural order and strengthens age-old natural processes.



### vi. Land Reclamation

Reclamation creates land for the future: industrial sites; residential areas; ports, airports and artificial islands. It is at the cradle of economic development. Volumes of sand are transported to the reclamation from a borrow zone at sea or material from capital dredging projects is beneficially used in major land reclamations.

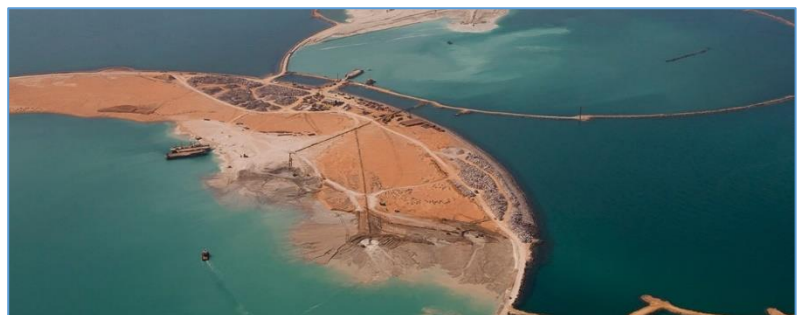



## Offshore



DEME Offshore is a leading provider of services and solutions for the offshore energy industry and has a strong track record spanning decades. The new company encompasses our renowned subsidiaries GeoSea, Tideway, A2Sea and EverSea. Integrating these well-respected, pioneering companies into DEME Offshore provides our customers with a comprehensive offering of solutions, services and equipment.

DEME Offshore is an agile organisation able to offer customers flexible, innovative solutions in both the oil & gas sector and in renewables. We offer a broad portfolio of services including foundation, turbine and substation Transport & Installation, cable laying, Operations & Maintenance activities, as well as full Engineering, Procurement, Construction and Installation (EPCI) and Balance of Plant contracts. For oil & gas and other offshore customers, services include landfalls and offshore civil works, rock placement, heavy lift, subsea construction, umbilical laying and the installation and decommissioning of offshore platforms. We also provide the offshore energy industry with geoscience expertise to help our customers successfully realise their projects from start to finish.

## Environmental

DEME Environmental Contractors (DEC), de Vries & van de Wiel, Ecoterres and Extract-Ecoterres are all part of Ecoterres Holding, DEME's group of specialist environmental companies. Their activities include soil decontamination, treatment of polluted soil and dredged sediments, as well as the high-tech cleaning of water, with a focus on design, build and operation using innovative techniques.

### i. Environmental Dredging

Environmental dredging is distinctly different from large-scale dredging because of the approach selected. With our advanced environmental dredging techniques DEME and its environmental companies, achieve the necessary high concentration of sediment with low turbidity during dredging.





## ii. Soil Remediation and Treatment

DEME's environmental companies are specialized in remediating contaminated soil and groundwater. To achieve this, the soil is both completely excavated and processed off-site or the soil and groundwater are processed using in-situ techniques



## iii. Landfill Techniques

The environmental companies of DEME have a long tradition in constructing and capping landfills, enabling our organization to assist the client throughout the whole process, from drafting the design, to the management and aftercare of the landfill.



## iv. Sediment & Sludge Treatment

DEME's environmental companies are specialized in the treatment of sediment and sludge and recycling techniques, which have been developed by our Research & Development over decades. Some of these technologies, such as Soft Soil Improvement®, have been specifically developed for in-situ treatment, while others are used on a daily basis in our fully certified sludge processing centers.





**v. Water Treatment**

As part of the globally active DEC (DEME Environmental Contractors), Purazur focuses on the high-tech treatment of industrial and domestic wastewater, landfill leachate and contaminated groundwater. Only 2.5% of all the water on our blue planet is fresh water, of which around 90% isn't even available. About 70% of the



available fresh water is currently being used around the world. Due to the further growth of the world population and the industrial development, both the need for fresh water and our global footprint will only increase.

**vi. Erosion Protection Works**

For more than 20 years, DEME's daughter company DEC has been active in preliminary studies, the execution and aftercare of a wide range of hydraulic works, especially where special asphalt materials are used.





## Infra Marine

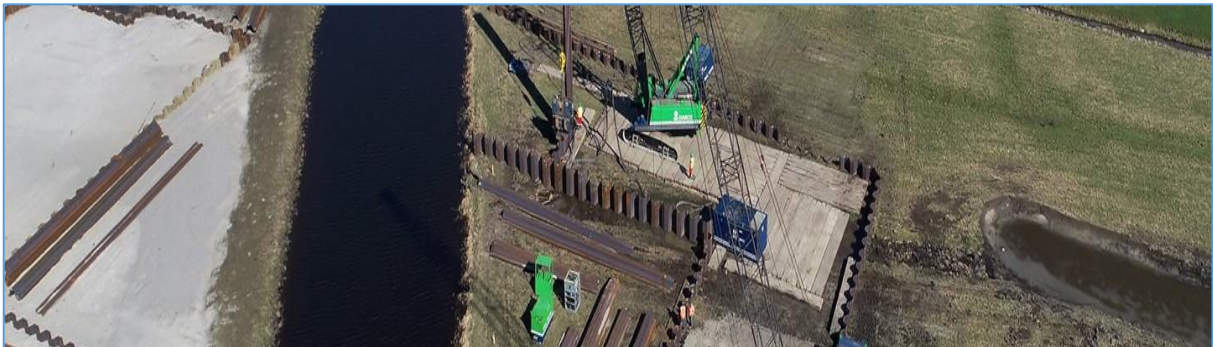

DEME's subsidiary DIMCO (DEME Infra Marine Contractors) is involved in marine infrastructure and civil works that complement and reinforce DEME's activities. These include design and construction of hydraulic and maritime works for jetties and port terminals, locks, weirs, bored/immersed/cut and cover tunnels, large and complex earth moving works, foundations and marine works for bridges and offshore constructions, civil works for harbour construction, dams and sea defenses, canal construction, revetment work, quay wall construction and shore protection amongst others. The company also has a specialized engineering and design department, which can assist DEME clients.





## Vegase – Safety Engineering in Gas Detection, Liquid Hydrocarbon



The combination of its expertise in safety engineering, safety instrumentation and industrial IT enables VEGASE CONTRÔLE to design innovative industrial solutions for the monitoring of installations as different as STORAGE, that a VAPOCRACKER, or a BAG (Glove box) NUCLEAR. VEGASE CONTRÔLE offers a wide range of solutions ranging from simple point detection to integrated systems of several hundred sensors with multi-station and multi-profile supervision. Our field of intervention includes: the prescription, the studies, the supply, the realization, the commissioning and the maintenance on site.

### Design and distribution of security detection products



***explosimeter***

Catalytic oxidation, Infrared, surface sorption, catharometer



***toximeter***

Electrochemical Laser Optical Semiconductor



***oxygen meter***

Electrochemical liquid or gel, laser optics



***acoustic leak***

Sensor exploiting the noise emitted in the ultrasounds by a leak.

### Engineering and Realization of Security Systems



***measuring system***

Instrumented vein, sampling box

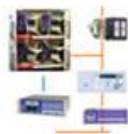

***acquisition systems***

Field Acquisition, Security Data Processing

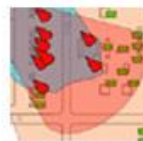

***supervision systems***

Multi-Risk Contract System, Decision Support System

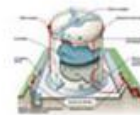

***securing storage***

Danger study, secure storage





## Gas detection

Transmitter sensors for gas leak detection allow atmospheric monitoring:

- The explosimeter for monitoring the risk of explosion.
- The toximeter for the monitoring of the toxic risk.
- The oxygen meter for monitoring the risk of anoxia.
- The wide-spectrum ultrasound sensor for global monitoring of noises emitted by leaks.

The sensors can be operated alone with their internal relays, in a safety PLC or through the proposed acquisition systems.

## Acquisition systems



**Mural or Rack 19 "**

19 " rackmount multi-channel acquisition system for 100 channels or wall-mounted

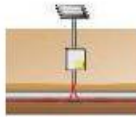

**Standalone radio beacon**

Autonomous management system -> no wired infrastructure



**multiplexer**

Specific multi-transmitter concentrator for the realization of zoning.



**Bysecure bus**

Digital Loop Acquisition System.

## Trace detection

### Families of analyzers



**Hygrometer**

Selective measurement of H<sub>2</sub>O Hygrometry by Infrared Absorption



**oximeter**

Oxygen O<sub>2</sub> selective measurement by infrared absorption



**Selective toximeter**

Selective measurement of gas traces by absorption Infrared laser CH<sub>4</sub>, HF



**VOC Toximeter**

VOC Measurement Volatile Organic Compounds by PID Photo-ionization.







## Specialized Fire / Flame Detection

### Range of fire solutions



**Multiple Infrared Flame**

Optical detection of flame multi spectre Infrarouge IR3



**Combined Flame Detection**

Optical Flame Detection  
Ultraviolet Combined Multi-Infrared UV2IR



**Reactor™ detection system**

Fire Detection and, or Extinction.  
Tube Destructive Thermo, Reactor™

## Liquid Detection

### Linear Liquid Leakage Sensor



**Liquid Hydrocarbon Detector Cables. Geo-location of Leak**

TT5000 Liquid Hydrocarbon Leak Detector (HL)



**Detector cables for Solvents, Ethanol. Geo-location of Leak**

Detector cables for Solvents, Ethanol. Geo-location of Leak



**Sensor cables for leakage of acids. Geo-location of Leak**

Linear Voltage Leak Detector TT3000

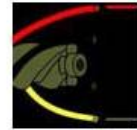

**Water Leak Detection Cables**

Linear Leak Detector TT3000

### Specific Detectors Sensor



**Fixed Hydrocarbon Liquid Detector**

Point sensor for detection. Fast Fuel Sensor TT FFS



**Hydrocarbon Pollution Detector Liquids supernatant**

TT FFS Fast Fuel Sensor and Flotation Instrumentation



**Hydrocarbon Piezometer Permanent**

Permanent liquid hydrocarbon detection system



**Piezometer Ethanol Permanent**

Permanent detection system Ethanol detector





## ProTXcoat – High Temperature Insulation and Repair Coating



### Repair



### Protect



### Upgrade



## ProTXcoat Coatings and Repair Materials Technology

ProTXcoat is manufacturing of engineered epoxy (novolacs) and polyurethane repair compounds and coatings. ProTXcoat was founded by the leading R&D experts and Application Engineers in the field of Composite Coating with decades of application experience! Our products and know-how are supplied to countries worldwide and are used by some of the largest companies globally.

ProTXcoat Corrosion Protection products are used in many industries and through our extensive worldwide network of contractors we are able to offer onsite technical support, training, presentations & seminars backed by project method statements & specifications.

We specialize in offering solutions against abrasion, wear, impact, chemical attack, leak repair and corrosion on process systems and equipment.

ProTXcoat combines two decades of know-how with service to: Petro Chemical Plants, Chemical Plants, Pulp and Papermills, Cement plants, Power Generation, Marine and Offshore, Food and Pharma, and general manufacturing.





## Metal

- Corrosion (Corrosion Protection System)

ProTXcoat Corrosion Protection products are ideal for protecting metallic and concrete surfaces from strong chemicals, weathering and UV degradation.

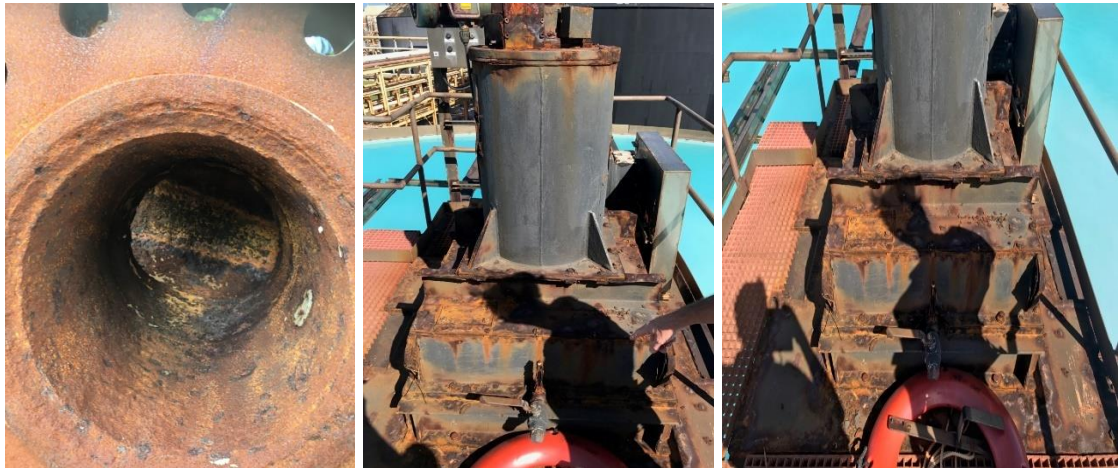

- Abrasion - Abrasion, Erosion, Wear and Impact Protection

The type of wear where particles move freely across a surface. Unless the metal is hard enough to resist, the particles cut grooves into the surface and cause costly shutdowns and replacements.



- Chemical Attack

Our Chemical Protection Coatings have been independently tested in full chemical immersion in industrial chemicals such as 98% Sulphuric Acid, Sodium Hypochlorite, 37% Hydrochloric Acid and Sodium Hydroxide.





- Pump Repair

Our pump repair and lining materials are proven to protect metallic surfaces from sea, river, drinking and waste water, as well as giving excellent resistance to a wide range of industrial chemicals.

- Heat Exchangers

ProTXcoat offers an extensive range of epoxy-based metal repair materials and ceramic coatings designed to repair and protect heat exchangers from erosion and corrosion.



- Flange Repair and Reforming

ProTXcoat two component solvent free epoxy Novolac coating designed for high temperature immersion conditions. Once cured it can withstand continuous immersion conditions up to 150°C and can upgrade the performance of conventional materials of construction.



- Pipeline Coatings

Sustainable eco-efficient Pipeline-coatings and asset conservation. ProTXcoat offers Epoxy and Polyurethane systems for optimal protection in harsh environments.





- Tank and Vessels

ProTXcoat offer rigid protection to steel and concrete tanks and storage basins.



## Concrete

- Concrete Repair

A fast curing 3-part concrete mortar which is ideal for repairs to damaged concrete surfaces.



- Concrete Protection

ProTXcoat has a diverse range of concrete repair materials that can repair badly damaged cementitious surfaces and protect them from wear, abrasion and chemicals





- Containment Areas

ProTXcoat Chemical Containment coatings offer outstanding chemical resistance to a wide range of industrial chemicals.

- Safety Flooring

ProTXcoat floor coatings and screeds providing highly durable and wear resistant surfaces.



- Self-Levelling Floor Systems

ProTXcoat floor coatings are a range of solvent free epoxy resin based systems ideal for resurfacing and rebuilding concrete surfaces.

## Maintenance

- Leak Repair

ProTXcoat pipe repair and pipe wrapping materials can be used to isolate and seal small pinholes or cracks in process pipework, or used to encapsulate long lengths of large diameter pipe.

- Plate Bonding

ProTXcoat metal repair systems are recognized throughout industry as a credible alternative to welding. Seal leaking tanks & pipes, cold bond irregular shaped surfaces by using our epoxy metal repair systems





- Maintenance Repair and Overhaul Supplies

ProTXcoat has a wide range of products ideally suited to the Maintenance, Repair and Overhaul market. From metal repair to underwater repair and concrete repair materials, our product range is used across the world to repair, protect and upgrade components, equipment and process systems.

## Roof and Waterproofing Systems

- Waterproofing and Sealing

Range of single component waterproofing materials is able to seal virtually any surface with a strong, flexible membrane to give long term protection from UV degradation and weathering. The ProTXcoat range of waterproofing materials includes water-based acrylic, solvent based acrylic & solvent based polyurethane coatings.



- Gutter Repair

ProTXcoat offers a range of solvent based and water-based roof and gutter repair membranes that are designed to seal and protect bitumen, concrete, metal and GRP surfaces.

- Roof Repair

ProTXcoat roof and gutter membranes give year-round coating capability, and can even seal leaking roof surfaces through ponded water.





## Marine and Offshore

- Onboard Repair Kits and Marine Coatings

ProTXcoat's comprehensive range of rapid and cold-curing marine coatings and metal repair composites has been used by the marine industry for many years. Our products are specifically designed to withstand harsh offshore conditions and have exceptional resistance against erosion and corrosion.

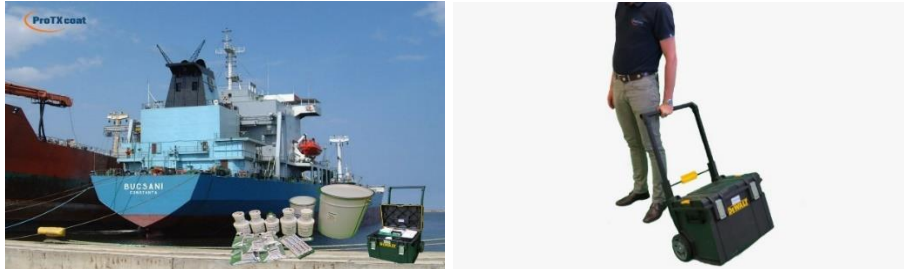

- Rudder and Propeller Repair

ProTXcoat ceramic enhanced coatings and engineering repair materials can be used to rebuild, resurface and protect metallic surfaces subject to cavitation, bi-metallic corrosion and abrasion.



- Hull Coatings

ProTXcoat offers a wide range of coating systems for both Dry-Dock repairs, new builds and onboard maintenance.



- Leak Repair

Range of pipe repair materials are based on the latest epoxy and polyurethane resin technology. ProTXcoat pipe repair and pipe wrapping materials can be used to isolate and seal small pinholes or cracks in process pipework, or used to encapsulate long lengths of large diameter pipe.







## Sacrificial Anodes with Induction Melting Technology



### HOUSTON ANODES GROUP

- Protecting Offshore, Subsea and Onshore Assets and Infrastructure since 1977.
- Designing, Manufacturing and Delivering High-Quality Aluminum and Zinc Sacrificial Anodes.
- Equipped with a state-of-the-art laboratory and superior induction melting technology.
- Headquartered in the Energy Corridor of Houston, TX.
- Management System Certificate ISO 9001-2008 by DNV.



### CORROSION

- **Metals** extracted from its primary ore (**metal oxides**) have a **natural tendency to revert to that state** under the **action of oxygen and water**.
- **Corrosion** is an **electro-chemical process** that involves the passage of electrical currents on a micro or macro scale by an “**anodic**” reaction.
- This reaction **produces free electrons**, which pass within the metal to another site on the metal surface (**the cathode**), where it is consumed by the “**cathodic**” reaction.
- **Corrosion process** is initially caused by:
  - **Difference in natural potential** in galvanic (bimetallic) couples. **Metallurgical variations** in the state of the metal at different points on the **surface**.
- Oxygen **rich** areas become the **cathode** and oxygen **depleted** areas become the **anode**





## CATHODIC PROTECTION

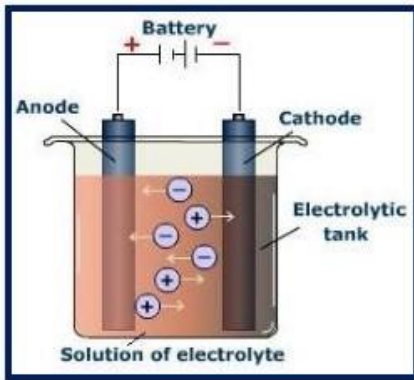

- The principle of **Cathodic Protection** is in connecting an external anode to the **metal to be protected** and the passing of an **electrical dc current** so that all areas of the metal surface become **cathodic** and therefore do not corrode.
- The current is a result of the **potential difference** between the two metals.
- Causes a **positive current** to flow in the electrolyte, from **the anode to the steel**.
- **Surface** of the steel becomes **more negatively charged** and becomes the **cathode**.

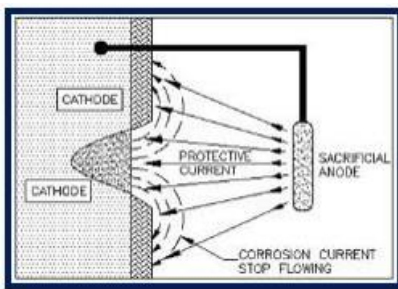

- A **Galvanic System** requires:
  - Sacrificial anodes**
  - Direct welding** to the **structure** or a **conductor connecting the anode to the structure** operations.

## HOUSTON ANODES GUARANTEE

**Homogeneous alloys** always conforming to **exact international quality standards** and **specifications**.

**NACE SP-0387 & SP-0492, DNV RP B401, ISO 155589-2, NORSOK M-503**

Houston anodes are fabricated using only **raw materials** of the **highest purity**, assuring **superior electrochemical** and **chemical properties**.

Our team of professional engineers, manufacturing and sales personnel are committed to provide the best products with **unparalleled customer service**.





**NOT A SINGLE CLAIM IN 40 YEARS**



**QUALITY CONTROL**

- **In-house state-of-the-art Laboratory** equipped with a **Bruker-Quantron Magellan Q8 spectrometer**.
- **All raw materials inspected and tested** upon arrival **prior to release for production**.
- **Chemical results verified against MTR's**.
- **Chemical analysis performed on every heat**.
- **Electrochemical properties** performed on every batch according to **NACE TM-0190**.
- **Rigorous Inspection and Testing Points**.
- **Scheduled equipment calibration per OEM**.



**RAW MATERIALS**

- **Primary High-Grade Raw Materials**
- **Premium US and global suppliers**
- **Primary Aluminum - 99.9% purity**
- **Special High-Grade Zinc - 99.99% purity**
- **Indium - 100% purity**
- **ASTM Steel - anode cores & mounting structures**

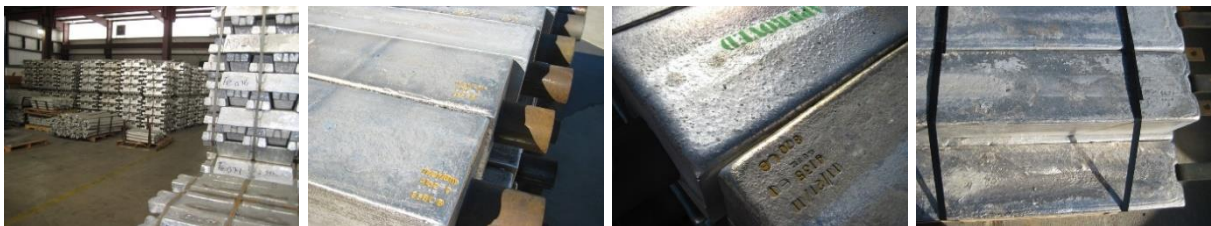



## TECHNOLOGY

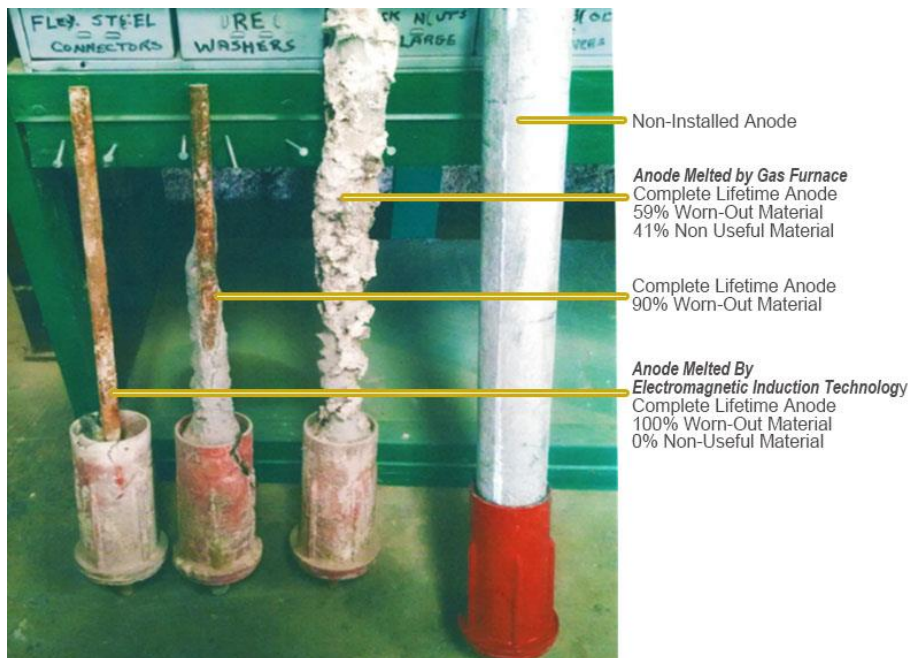

## ADVANTAGES

- **Guarantees an 100% homogeneous alloy of exceptional purity of the electrochemical composition.**
- **Controlled temperature melting process.**
- The process assures **identical results**.
- **Consistent batches** and final product **every time**.
- **Heat** is produced **instantly** and within the metal being melted.
- Without flames and without touching the material to be heated.
- **Fast Cycle Times**
- **Free of Hydrogen & Carbon Bubbles Porosity**
- **Favourable working conditions**
- Doesn't heat up surrounding area or environment.
- **Environmentally Friendly**
- **Clean** and **odourless** heating process.
- **No harmful emissions or noise**
- No polluting fuel or burners
- **Energy Efficient**
- Power is on only when being utilized.
- **Reduced metal loss.**
- Better product yield.





**SAFER, EMISSIONS FREE, REDUCE METAL LOSS**



**GLOBAL PRESENCE**  
Successfully delivered Sacrificial Anodes worldwide to  
Top 100 Energy Companies





## RECOAT Antimicrobial Protective Coating System



— RECOAT —

Recoat coatings **restore and protect your substrate permanently**. The surface becomes dirt and water repellent. Due to this, the surface is permanently protected against discoloration, graffiti and weathering. This results in significantly lower maintenance costs.

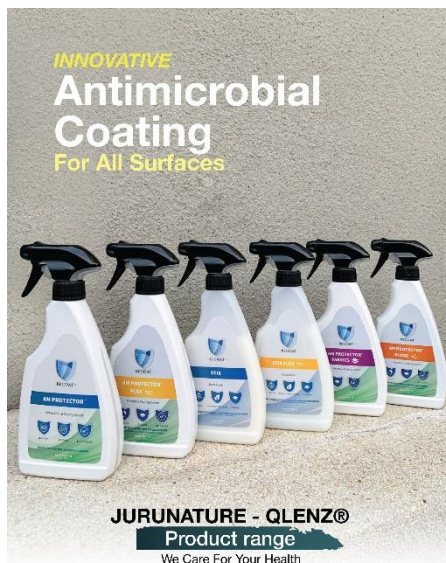

Recoat coatings are **water-based, contain virtually no solvents, are economical to use and are sustainable**. In addition, they are easy to work with and can be applied to almost any surface. All of this without sanding on beforehand. We are constantly in the process of developing new coatings and improving our current coatings to help you protect your substrates.

Recoat products contain very little solvent. The lifespan of the surface is extended for an indefinite period because of this further treatment or replacement becomes unnecessary. This saves energy and raw materials that would be needed for treatment and replacement.



**AM Protector®** is a water-based clear coating that is very easy to apply. Due to the smooth structure, dirt does not adhere to the surface and the surface is easy to clean. The coating also ensures that treated surfaces are bacterial and fungal resistant.

The coating provides a permanent thin paint film which is suitable for almost all surfaces where hygiene is extremely important.





**AM Protector® Fabrics** is a water-based clear coating that is very easy to apply to fabric substrates. The coating ensures that treated surfaces are bacterial and fungal resistant.

The coating provides a permanent thin paint film which is suitable for almost all surfaces where hygiene is extremely important. The coating provides a permanent thin water and dirt repellent flexible layer that is suitable for curtains and upholstered furniture etc. For fabric surfaces where hygiene and cleanability are important.



**AM Protector® Flex** is a very flexible water-based clear coating that is very easy to apply. Due to the smooth structure, dirt does not adhere to the surface and the surface is easy to clean. The coating also ensures that treated surfaces are bacterial and fungal resistant.

The coating provides a permanent thin paint film which is suitable for almost all surfaces where hygiene is extremely important.



**AM Protector® Gloss** is a water-based clear coating that is very easy to apply. Due to the smooth structure, dirt does not adhere to the surface and the surface is easy to clean. The coating also ensures that treated surfaces are bacterial and fungal resistant.

The coating provides a permanent thin paint film which is suitable for almost all surfaces where hygiene is extremely important.





**The Recoat cleaner** is a universal cleaning and degreasing agent that leaves no residue.



**Recoat Stix** ensures optimal adhesion, seals the substrate, restores colours and is ideal for the preparation of metals and powder coated surfaces.

Recoat Stix is an adhesion promotor and sealer in one, ensures the coating system is closed, and enhances the optical finish. Recoat Stix is suitable for practically all hard substrates, as well internal as external. Recoat Stix must always be top coated with a finish coat.

Recoat Stix preferably is applied with a microfibre cloth. This prevents splashes and spilling material. Application by roller or brush is possible as well. Recoat Stix reduces consumption of the finish coat and delivers an optimal end result. Avoid working in direct sunlight, in connection with the fast curing capabilities.



**Recoat Stix Flex** ensures optimal adhesion, seals the substrate, restores colours and is ideal for preparation of leather, artificial leather, rubber and soft closed plastics.

Recoat Stix Flex is an adhesion promotor and sealer in one, ensures the coating system is closed, and enhances the optical finish. Recoat Stix Flex is suitable for practically all flexible substrates, as well internal as external. Recoat Stix Flex must always be top coated with a finish coat.

Recoat Stix Flex preferably is applied with a microfibre cloth. This prevents splashes and spilling material. Application by roller or brush is possible as well.

Recoat Stix Flex reduces consumption of the finish coat and delivers an optimal end result. Avoid working in direct sunlight, in connection with the fast curing capabilities.

When using Recoat AM Protector® Flex pre-treat the surface with Recoat Stix Flex for optimal adhesion and minimal consumption of the Recoat AM Protector® Flex.







## VSAT Systems and ICT Solutions



### VSAT Systems

**JURUNATURE** continues to provide best in class service to the industry and through its partnership with ITC Global which is the world's leading satellite network for highly connected remote operations.

We specialize in satellite-based communications for industrial operations in extreme environments, including deep-water energy exploration, remote mining and transoceanic shipping. Today our partner, ITC Global is the number one provider of satellite communications networks to the mining industry and among the top three providers to the oil and gas industry.



### ICT Solutions

**JURUNATURE** is proudly to present our ICT technology products and services that offer comprehensive solutions including the provision of research, design, development, marketing and maintenance services or supply chain solutions, turnkey software development for other business application, professional IT services, hardware and software products implementation.

Furthermore, we provide consultancy service to clients regarding technical, operational and project management for their holistic systems. These include, but not limited to, issues on back-end integration, security issues and online strategy. The Company services large multinational companies on their worldwide integration compliance.



DELL EMC



Hewlett Packard  
Enterprise





## HEALTH, SAFETY & ENVIRONMENT



At **JURUNATURE**, we believe that Health & Safety forms an essential priority in conducting our business.

The health, safety and well-being of our employees is of utmost importance and as a company, we continually work to ensure all employees place the same emphasis towards health and safety during the course of conducting our business. We also firmly believe that the co-operation and commitment of all employees is essential in achieving the highest standard in Health, Safety and Environment management.

In ensuring a sustainable safety culture, we empower our staff to continually improve and spread the safety message by ensuring they themselves work safely and in accordance with the company's safety procedure requirements and legislative requirements.

In pursuing our goal of "Zero Harm to People, Damage to Assets and Environment".





**JURUNATURE** is committed to the following:

- Clear identification of work and carrying out a detailed risk assessment and making sure relevant information about work place hazards and their control measure are available to our employees and business partners at all times
- Making sure that Safety, Health and Environment obligations are precisely determined and communicated
- Ensuring that all our employees and business partners are provided with information applicable to legislative standards and requirements
- Carrying out exhaustive audit and reviews of our sites to ensure full compliance
- Carrying out routine senior management and board reviews of safety performance and to initiate counteractive actions as necessary
- Ensuring our employees and business partners are involved and consulted on all safety matters
- Ensuring sufficient resources are made available to achieve the objectives of the company's policies and procedures

**JURUNATURE** strives to uphold the health safety & environmental aspects in its manufacturing and business operations by:

- Complying to ISO 14001 & OHSAS 18001 standard requirements, applicable legal requirements, as well as client requirements with regards to HSE and shall make available all documents, services and facilities related to HSE issues so as to enable proper performance of HSE related activities
- Preventing pollution, injury and ill-health protect its employees, the environment and all third parties including their equipment's from any hazard that may arise as a result of the WORK
- Continuously improving the HSEMS and ensuring its effective implementation for continual improvement
- Conserving natural resources from extinction.





## Major HSE Appreciation





# Petronas – BOKOR CPP Phase 3 Redevelopment Project Awards



### Awarded BEST SUBCONTRACTOR



### HSE Award - 1 million Safe Man-Hours



### Focused Recognition





# Project Awards

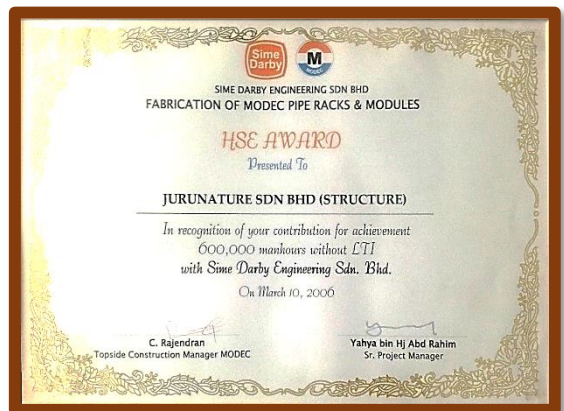





## QUALITY ASSURANCE & CONTROL

### Quality

Our prime objective is customer satisfaction and confidence. This is centered on the products we market and the product support services we are able to provide our customers.

We are fully committed to the concept of Total Quality Management and seek continuous improvement in all of our businesses and operations. In our quest for excellence, we recognize that the co-operation of our employees and our business partners is vital.

We have developed our Quality Culture based upon open and honest communication. We believe in establishing long term partnerships with customers, employees, suppliers and we manage our business in an open manner. We have programmes in place whereby our employees are encouraged to review, develop and contribute fully, towards improving all our processes. We bring our experience, best practices and tools to be applied to our business partner's specific business requirements.

Some highlights of our quality system are:

- A quality culture that stands for delighted business partners, committed employees and continuous improvement
- Proven practices
- Striving to meet our goal of Zero Defects
- ISO 9001:2015 since June 2008







## Quality Policy

**JURUNATURE** strives to become a vast and dynamic business organization by:

- Complying to or surpassing the ISO 9001 standard requirement, applicable legal requirement, as well as client requirements
- Continuously improve the effectiveness of the JURUNATURE Quality Management System
- Ensuring quality of production services that meets the quality standard at a competitive price
- Providing a conducive & proper work environment in order to achieve
- JURUNATURE's Quality Policy
- Enhance the knowledge, know-how and motivation of our employees depending on the development of knowledge and technology applicable to JURUNATURE's operation, to make sure continuous client satisfaction.





# ISO CERTIFICATIONS



**Quality Management System**



**Environmental Management System**



**Occupational Health & Safety**





## CLIENTELES & KEY ACCOUNTS



PETRONAS



CARIGALI HESS

ExxonMobil



Lundin  
Petroleum



ALAM MARITIM  
RESOURCES BERHAD





## KEY INTERNATIONAL PARTNERS





## LICENSES AND CERTIFICATIONS

*PETRONAS LICENSES*

*MOF CERTIFICATION*

*CIDB MALAYSIA*

*DEWAN PERNIAGAAN MELAYU MALAYSIA*

*SURUHANJAYA TENAGA*

*SIJIL PEROLEHAN KERJA KERAJAAN (SPKK)*

*TENAGA NASIONAL BERHAD*



