

JURUNATURE SDN BHD

Your First Choice Partner in Oil and Gas



COMPANY

PROFILE



JURUNATURE SDN BHD

Your First Choice Partner in Oil and Gas

Suite 4-07, Level 4
AMODA Building
22 Jalan Imbi
55100 Kuala Lumpur, Malaysia

Tel: +6 03 2711 1011
Fax: +6 03 2711 1022

Website: www.jurunature.com
Email: sales@jurunature.com

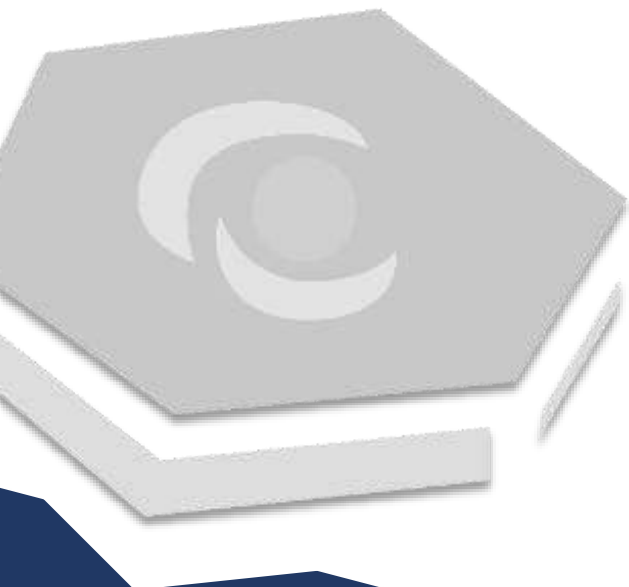



TABLE OF CONTENTS

COMPANY BACKGROUND	3
Profile	3
Corporate Information.....	4
Vision, Mission, and Shared Values	5
Company Policy.....	7
COMPANY STRUCTURE.....	8
Organization Chart.....	8
Our people	9
BUSINESS ACTIVITIES	11
PRODUCT AND SERVICES.....	13
Product and Services Overview.....	13
HiCO ₂ Dry Ice Blasting.....	15
HUMIDUR® Single Coating.....	25
Passive Fire Protection.....	35
<i>JURUNATURE</i> 's PFP Casting System	36
JuruFlex - J120 - Jet Fire Jacket System.....	38
Fire & Blast Protective Systems.....	39
Fire Rated Doors	40
FRP Grating and Handrails.....	41
Welding Electrodes.....	42
Field Joint Coatings	43
Enerthem Sprayable Insulating Coating	44
C-Saddle Pipe Supports	45
Deepwater Capabilities and Remote Inspection	46
Topside Robotic Inspection.....	48
Emission Monitoring and Reporting	49
Fabrication Works.....	50
VSAT Systems and ICT Solutions	51
HEALTH, SAFETY & ENVIRONMENT	52
Major HSE Appreciation	54
Other Project HSE Awards	55
QUALITY ASSURANCE & CONTROL.....	56
Quality	56
Quality Policy	57
CLIENTELES & KEY ACCOUNTS.....	58
KEY INTERNATIONAL PARTNERS.....	59
LICENSES AND CERTIFICATIONS	60





COMPANY BACKGROUND

Profile

JURUNATURE SDN. BHD. (hereinafter also referred to as "**JURUNATURE**") was incorporated and registered on 8th April 1999 with the intention of focusing in trading of niche products and providing best-in-class services, specializing in the Oil and Gas (O & G) / Petrochemical industry. As a prudent company and in order to succeed in this highly competitive trade, the Company realized the need to aggressively research the global markets for products that are innovative, practical and much sought after by the Oil and Gas industry.

After an extensive 10 months of deliberation and fact-finding on products, **JURUNATURE** became active and began securing partnership arrangements and pairing-up with major International trading companies beginning March 1, 2000.

Today, **JURUNATURE** is proud to be credited as a system and service provider of innovative safety solutions to the oil & gas petrochemical industry. We endeavor to tailor a package that provides the most technically advanced system, product, and service solution that meets the budgetary constraints of our Clients.

Through an extensive knowledge of the industry from the inside as a Client and from the outside as an EPIC Contractor, **JURUNATURE** has developed a complex yet highly effective and sophisticated global network of suppliers and partners, which we truly believe that **JURUNATURE** have mastered the discipline of smart-partnering.

JURUNATURE has successfully collaborated with distinguished and leading International companies in representing their presence in Malaysia. Numerous leading international companies have shown their absolute confidence in the Company by appointing the Company to be their **EXCLUSIVE** Agent/Partner in Malaysia.





Corporate Information

Registered name of Company	:	JURUNATURE SDN. BHD.
Date of incorporation	:	8 th April, 1999
Office address	:	Suite 4 – 07, Level 4, AMODA Building, 22 Jalan Imbi, 55100 Kuala Lumpur
Telephone	:	+6 03 – 2711 1011
Fax	:	+6 03 – 2711 1022
Authorized Capital	:	RM 5,000,000.00
Paid-up Capital	:	RM 1,000,000.00
Board of Directors	:	Dato' Sri Muhammad Syafiq Bin Abdullah Datin Sri Dr. Maison Binti Shaik Abdul Rahman Abdul Hanif Bin Abu Bakar
Company Secretary	:	HOMELAND Consulting Sdn Bhd (Tan Yen Nee – MAICSA 7026045)
Banker's Name and Address	:	ALLIANCE BANK MALAYSIA BERHAD 150 – 152, Jalan Cerdas, Taman Connaught, 56000 Cheras, Kuala Lumpur
Accountant	:	NASHARUDDIN WONG & CO 3A01, Block A Pusat Dagangan Phileo Damansara 1 Jalan 16/11, Off Jalan Damansara 46350 Petaling Jaya, Selangor
Certifications	:	ISO 9001 : 2008 Quality Management System OHSAS 18001 : 2007 ISO 14001 : 2004 Environmental Management





Vision, Mission, and Shared Values

Core Values

Focus on customers	We always strive to exceed customers' expectations.
Deliver results	We are driven by result through innovation and continuous improvement.
Value people	We work as a team, respect and care for one another.
Uphold integrity	We demonstrate integrity in our words and actions.
Mutual respect and trust	In everything we do, in every interaction, both, we strive to operate with the upmost mutual respect and trust in every interaction both internally and externally
Open communication	Partnerships with our customers and co-workers must be based on trust, professionalism and transparency.

Philosophy

JURUNATURE will keep contributing positively to the achievement of Malaysia's VISION 2020 by developing and growing our resources and increasing our competence in our specialized fields of work.

JURUNATURE will maintain the highest level of Quality, Safety and Environmental standards and awareness in all work that we undertake, no matter the size and that we will continue to ensure all work done is done to the highest level of client satisfaction.

JURUNATURE will continue to be a company with a strong Corporate Social Responsibility and it is our aim to continually honour our obligations to our shareholders, employees, stakeholders, clients and partners.





Vision

"Your First Choice Partner In Oil & Gas"

Mission

- Creating values in the Oil and Gas market by providing high end technology solutions and offerings in line with Malaysia's aspiration to be an innovation-led economy.
- We strive to be the global leader in providing products and services of unsurpassed quality for the oil and gas industries, adding value to all of our clients as well as exceeding their expectations.
- To exceed the needs and expectations of our customers at all times by continuously providing high quality products and services, complying fully with their specified requirements on time and within budget.
- Enhance our shareholders' value through its employees and providing a dynamic environment for both our employees and sub-contractors by creating an atmosphere of optimism, teamwork, creativity, resourcefulness.





Company Policy

With qualified and technically experienced staff, the company is maturing into a vast and dynamic organization. Continuing to strive for excellence, the company is stepping up efforts in being recognized as a major trading company with unmatched records in all fields the Company ventures into.

Our company policies are:

- To strive for excellence and be recognized as **THE** leading company in its field of business.
- To establish and maintain good working and mutually beneficial relationship with all clients.
- To sustain the highest Safety and Health standards and to ensure the Safety and Health of its employees are given the highest priority.
- To ensure highest standards in ethics and integrity are complied with.
- To be very competitive in pricing, yet uncompromising in the quality and professionalism of work completed, and
- To be sensitive to the environment and conserve the state of the environment.





COMPANY STRUCTURE

Organization Chart

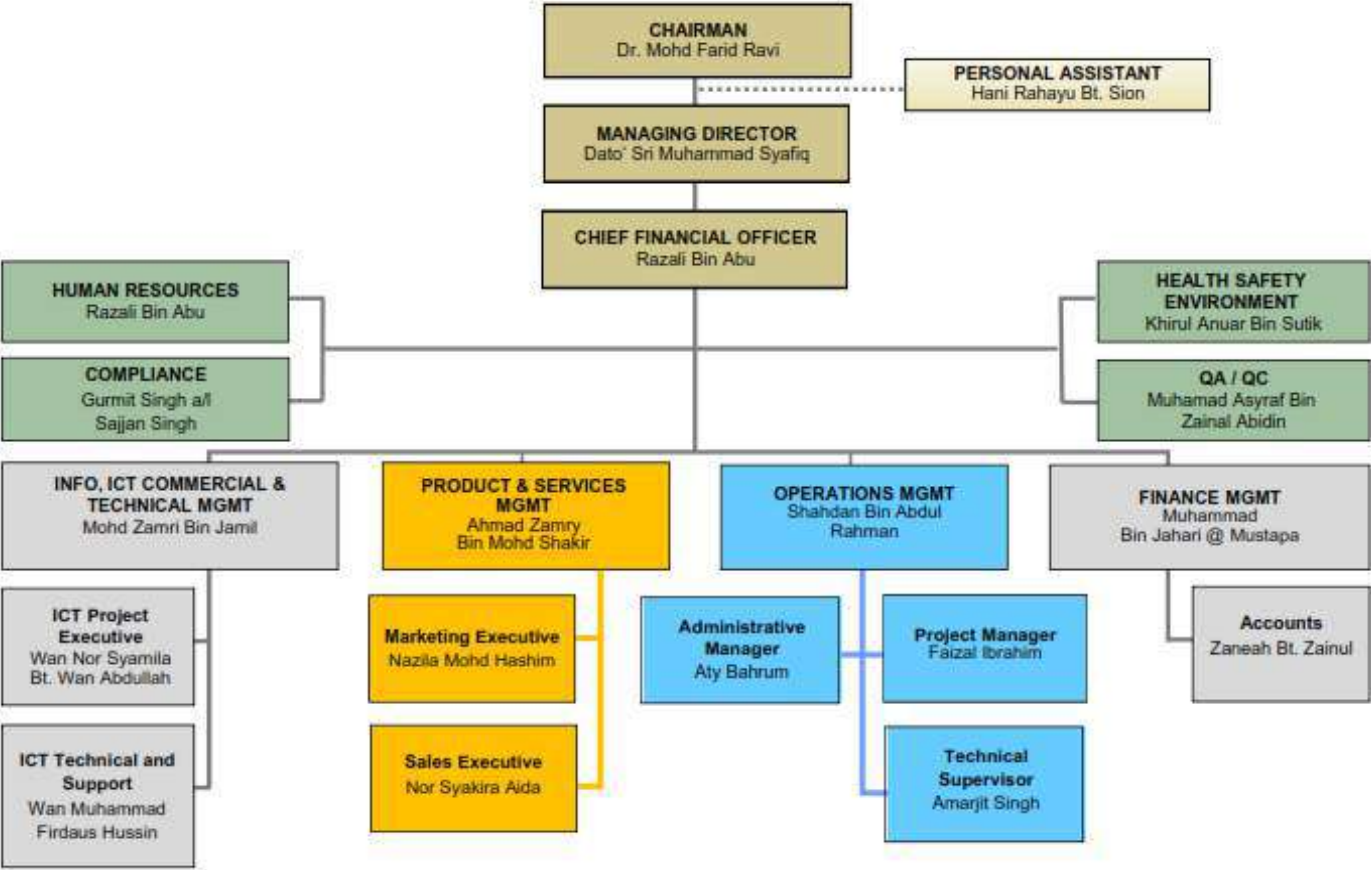



Our people



We understand that our people are the key to our success and we're committed to:

- **Fostering a culture based on our beliefs and behaviors** – Our beliefs unite us to do the right thing, help others and realize potential and are supported by a set of behaviors that ask us to be authentic and respectful, work together and create value through excellence.
- **Improving health, wellbeing and lifestyle** – providing a safe and healthy work environment, as well as a range of benefits to ensure work/life balance.
- **Providing career development opportunities** – supporting individual goals, providing career paths and ensuring performance is matched by reward.
- **Fostering a culture of achievement** - through providing innovative learning opportunities.
- **Flexible working** - providing real choices to manage the balance between work and personal life.
- **An inclusive workplace environment** – creating a culture where men and women from an array of different backgrounds, generations and cultures feel genuinely included and valued.
- **Creating opportunities for community involvement** – through opportunities to work directly on community activities, providing support and processes to make this happen or by taking time to give back.







BUSINESS ACTIVITIES

JURUNATURE as an EPIC Contractor, **JURUNATURE** has developed a complex and yet highly effective and sophisticated global network of suppliers and partners.

In the area of product offer, **JURUNATURE** has successfully collaborated with distinguished and leading International companies in representing their presence in Malaysia. Several leading International companies have shown their absolute confidence in the Company by appointing the Company to be their EXCLUSIVE Agent/Partner in Malaysia.



MLNG 3 SLUGCATCHER PROJECT



HELANG TOPSIDES PROJECT



KIKEH DTU TRUSS SPAR PROJECT



KIKEH DTU TRUSS SPAR PROJECT





Johor



BERBAPA orang pengkimpal melakukan kerja mengikut kategori dan kemahiran masing-masing di Jurunature, Pasir Gudang, Johor. - UTUSAN/RAJA JAFAR/MI

Jurunature lahirkan lebih ramai jurukimpal berkemahiran tinggi Kerja tidak glamor tapi lumayan

utusanjohor@utusan.com.my

JOHOR BAHRU 10 Mei - Mungkin ramai yang menganggap kerja sebagai jurukimpal tidak glamor, namun ia sebenarnya memberi pendapatan lumayan kerana tidak ramai yang memiliki kemahiran tersebut.

Menyadari potensi itu, sebuah syarikat bumiputera, Jurunature Sdn. Bhd., bertekad melahirkan lebih ramai pekerja mahir dalam bidang kimpalan gas dan petroleum.

Bagi 'mengiktiraf' profesion tersebut, syarikat berkenaan melancarkan program akreditasi bagi para pekerja yang baru-baru ini untuk memahatkan sebarang kerjaya bagi melahirkan lebih ramai pekerja mahir dalam sektor berkenaan yang berpendapatan tinggi.

Pengarah Urusannya, Datuk Seri Muhammad Syafiq Abdullah berkata, pihaknya mengambil langkah proaktif bekerjasama dengan Lembaga Pembangunan Industri Pembinasaan (CIDB) melancarkan akreditasi atau ujian kemahiran itu supaya mereka mempunyai nilai tambah dan seterusnya dapat bersaing dalam pasaran tempatan dan antarabangsa.

"Kita mahu menjadi contoh kepada syarikat lain yang menyediakan program akreditasi untuk para pekerja dan yang penting melalui kerjasama strategik ia memberi pendedahan dan membuka mata syarikat binaan untuk memasarkan setiap pekerja mendapat perakuan akreditasi CIDB.

"Kita merancang memberi tau-



INILAH kad perakuan bagi seorang jurukimpal bertauliah di Jurunature, Pasir Gudang.

lian kepada 400 lagi kakitangan di syarikat kami secara berperingkat-peringkat, bagi membolehkan mereka terus melangkah jaitu bukan sahaja di dalam negara, malah ke peringkat global kerana ia menjamin pendapatan lumayan," katanya kepada Utusan Malaysia di sini baru-baru ini.

Muhammad Shafiq berkata, tu-

juan syarikatnya mengendahkan program itu kerana CIDB bakal memajukan semua pekerja binaan di negara ini mendapatkan akreditasi atau pentauliahkan yang dijangka dilaksanakan awal tahun depan bagi semua pekerja binaan tempatan yang mempunyai tahap kemahiran yang menepati Standard Kemahiran Industri Pembinasaan Kebangsaan.

Menurusi program akreditasi itu, pekerja binaan akan menjalani satu ujian praktikal untuk mengesahkan kemahiran yang dimiliki dikira bagi memenuhi piawaian.

Menurutnya, Jurunature berharap bukan sahaja dapat melahirkan lebih ramai jurukimpal berkemahiran tinggi, cekap serta mencapai standard

Jurunature berharap bukan sahaja dapat melahirkan lebih ramai jurukimpal berkemahiran tinggi, malah membentuk jurukimpal berkualiti, cekap serta mencapai standard keperluan industri petroleum dan gas yang semakin berkembang.

MUHAMMAD SYAFIQ ABDULLAH
Pengarah Urusan Jurunature Sdn. Bhd.



AHMAD ALI

keperluan industri petroleum dan gas yang semakin berkembang.

Sementara itu Pengurus Besar Jurunature, Ahmad Ali berkata, sejak syarikat itu ditubuhkan 12 tahun lalu, kira-kira 8,000 jurukimpal terlatih telah dilahirkan pihaknya.

Lebih membanggakan, katanya, sebahagian besar daripada mereka bukan sahaja telah keluar daripada garis kemiskinan, malah kini mampu mendapat pendapatan antara RM3,000 hingga RM6,000 sebulan.

"Kami turut berbangsa kerana kira-kira 100 jurukimpal yang telah ditawarkan bekerja di pelantar minyak mendapat gaji RM450 hanya untuk dua jam bekerja sehari," katanya.

Orang ramai diminta bantu kesan Harmiza

JOHOR BAHRU 10 Mei - Polis meminta kerjasama orang ramai bagi mengesan seorang wanita, Harmiza Harudin, 29, yang dilaporkan hilang dari rumah sejak 10 Mac lalu.

Ketua Polis Daerah Seri Alam, Superintendan Roslan Zaimuddin berkata, mangsa yang tinggal di Nomor 36, Jalan Angsana I, Taman Rinting dekat sini dilaporkan keluar dari rumah untuk menghadiri temu duga kerja di Senai pukul 9.30 pagi dan tidak pulang ke rumah.

Rusteri, orang ramai yang mempunyai sebarang maklumat mengenai Harmiza boleh menghubungi Ketua Polis Balai Masai, Inspektor H. Ramatassan di talian 019-9201020 atau 07-3511222 atau mana-mua balai polis bertampan.

'Bidang yang menarik, beri kepuasan'

JOHOR BAHRU 10 Mei - Beberapa jurukimpal mengakui mereka mendapat pendapatan lumayan hasil ilmu dan kemahiran yang dipelajari di Jurunature Sdn. Bhd., di sini.

Sulaiman Selamat, 50, yang telah mencorubi bidang tersebut sejak 28 tahun berka, jurukimpal memaikan peranan penting untuk menghasilkan pelantar minyak dan gas dari segi pembinaan struktur, pemasangan lelasan paip serta kerja elektrik dan mekanikal.

"Pada dasarnya kerja mengimpal memerlukan tempaan dan ketelitian kerana keuntungan syarikat bergantung kepada kemahiran dan kebolehan jurukimpal," katanya.

Di yang menjadi penyelia di Jurunature kini mengakui bidang kimpalan merupakan bidang yang menarik dan memberi kepuasan kerana mampu memberi pendapatan sehingga RM6,000 sebulan.

Bapa kepada lima anak itu memberitahu, pada masa kasar, kerja kimpalan nampak mudah, namun ia berubahnya terutama kepada kes-



JAMALUDDIN

MOHD. ROSMAN

batan dan menuntut pegus mekai kelengkapan termasuk perlindungan muka.

Bagi Jamaluddin Shamsuddin, 35, yang sebelum ini menjadi peniaga gerai mula tertarik mendalami kemahiran sebagai pembantu jurukimpal sejak tujuh bulan lalu.

"Mula-mula saya buat yang kecil-kecil dan kemudian ikut senior baru boleh buat struktur yang besar," katanya sambil memberitahu hanya bersekolah hingga tahun

enam dan kini mampu memperoleh pendapatan kira-kira RM3,000 sebulan.

Mohd. Rosman Juminan, 43, yang hanya bersekolah sehingga tingkatan tiga pula memberitahu, minatnya dalam bidang itu berputik apabila melihat ramai rakannya memperoleh pendapatan lumayan sehingga mampu membeli rumah, kereta baru dan menara keperluan keluarga.

"Sebelum menjadi jurukimpal saya terpaksa menjalani ujian dua kali baru lulus, itu pun setelah mendapat tunjuk ajar dan belajar daripada mereka yang lebih mahir.

"Alhamdulillah dengan kebolehan dan kemahiran yang ada kini saya mampu memperoleh pendapatan antara RM4,000 hingga RM5,000 sebulan termasuk kerja lebih masa," katanya.



MEMAKAI topi khas, coram mata gelap dan menutup muka menjadi aspek keselamatan yang penting bagi seorang jurukimpal di Jurunature.

Johor

PEJABAT UTUSAN MALAYSIA

JOHOR BAHRU
T 07-3322880 / 3322906
F 07-3322934
E utusanjohor@utusan.com.my
utusan@ayah00.com

MUAR
T 06-9548667
F 06-9547515

BATU PAHAT
T 07-4327143
F 07-4318531



PRODUCT AND SERVICES

Product and Services Overview

JURUNATURE is now recognized as a leading provider of many specialist products and services to the industry. The company is further renowned for quality and production in-line / every time with the client's schedule.

Our range of products and services include:

- HiCO₂ Dry Ice Blasting
- Humidur Single Coating
- Passive Fire Protection Services
- JuruFlex - J120 - Jet Fire Jacket System
- Fire & Blast Protective Systems
- Fire Rated Doors
- FRP Grating and Handrails
- Welding Electrodes
- Field Joint Coating Services
- C-Saddle Pipe Supports
- Deepwater Capabilities and Remote Inspection
- Topside Robotic Inspection
- Emission Monitoring and Reporting
- Fabrication Works
- VSAT Systems and ICT Solutions





HiCO₂

DRY-ICE Blasting





HiCO₂ Dry Ice Blasting



Most innovative technology that uses high-density CO₂ as a form of blast medium, which eliminates the need for extraction, waste removal, and encapsulation. The process also offers you the opportunity to blast and paint at the same time. Used for removal of heavy corrosion, epoxy coatings, PFP coatings and hard scales and is the world's first corrosion removal system using dry ice. The world's first mobile high-density dry ice production system and are pioneers in offshore dry ice blasting projects. Significant savings due to the reduction of site preparation, clean-up costs and waste disposal costs as there is no waste as the ice evaporates. Significant time saving as it takes on 25% of the total time compared to traditional methods (eg. Grit blasting).

SURFACE PREPARATION

Recent tests have achieved the following results, following blasting with our system:

- Cleanliness inspection – in line with SA2.5 standard
- Profile reading – 70 microns after blasting Cat D corroded surface
- Salt readings – 0 after blasting the above
- Adhesion tests – readings of 15-27MPa achieved on the above surface after recoating

Generating a new surface profile

DI Global carried out TSA testing with the Shell TRT department.

Tests past which proved the DIG MM system is capable of producing a surface cleanliness & sufficient profiles to pass TSA adhesion and bend tests.





Technology achieves significant savings due to the reduction of site preparation, clean-up costs and waste disposal costs.

SAFETY AND ENVIRONMENT

Technology is safe to use, with reduced hazards to the operator and surrounding environment. The CO₂ we use comes from recycled sources.

TRACK RECORD

Our client list includes the following:

- Shell, Total, Valero, Nexen, EnQuest and Brunei LNG

CASE STUDY

The table below documents a recent case study and the savings that were achieved. The time savings were realised through the lack of encapsulation and clean-up, completing the scope in just under 25% of the time for traditional methods.

Activity	Grit Blasting	DIGMM System	Time Saving
Encapsulation	4.5 hours	0.2 hours	4.3 hours
Blasting	2 hours	2 hours	0 hours
Clean Up	2 hours	0 hours	2 hours
Total	8.5 hours	2.2 hours	6.3 hours

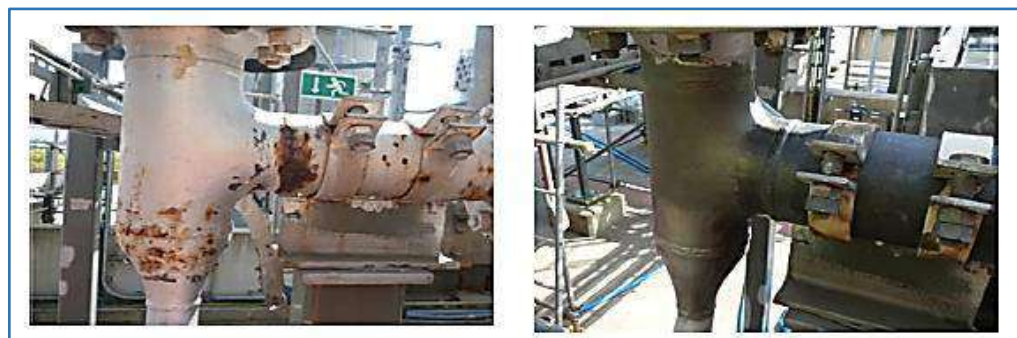



Comparison Between Conventional and HiCO₂ Dry Ice Blasting

Grit blasting

v

Dry ice blasting



- ❑ Time taken to tape up stainless steel and encapsulate first half:
 - 1 hour 30mins for x3 men
- ❑ Time taken to blast the first half:
 - 2 hours of trigger time x1man
- ❑ 27 bags of garnet
- ❑ 675 kgs of garnet
- ❑ Clean up all of Garnet:
 - 1hour x2 men
- ❑ Total Man hours for first half set-up, blast, clean up:

8hours 30 mins

- ❑ Time taken to tape up stainless steel and encapsulate FULL works:
 - 10mins x1 men
- ❑ Time taken to blast the FULL works
 - 1 hour of trigger time x2 men
 - 10 mins of Bristle blast x1 man
- ❑ 100kg of Dry Ice
- ❑ Clean up
 - N/A
- ❑ Total Man hours for FULL works set-up, blast clean up:

2 hours 20mins





Comparison Between Conventional and HiCO₂ Dry Ice Blasting (con't)

Grit blasting

v

Dry ice blasting





REMOTE PRODUCTION

HiCO₂ Dry Ice production units are fitted with the latest in dry ice production technology. Various sizes and capacities can be accommodated. Our standard equipment is delivered in a 10ft shipping container.





SUMMARY

Expertise:

- ✓ **Dry Ice Blasting** technology (either **HiCO2 alone** OR with **MM** under high air pressure to remove various contaminants)
- ✓ Pioneer in **offshore dry ice blasting** projects
 - The revolutionary, patented technology has been developed specifically for **surface preparation and fabric maintenance purposes** in the Oil & Gas industry, and similar applications
- ✓ World's first **heavy corrosion removal technology** using dry ice
- ✓ Removal of **epoxy coatings, PFP coatings & hard scales**
- ✓ **No salt residue** (eliminate premature coating failure)
- ✓ World's first **mobile high-density production system**
- ✓ The technology achieves **surface preparation** in line with international coating standards, and has been **approved by major coating suppliers**.
- ✓ Equipment is **ATEX Certified** for use in **Zone 1** environments.

Ultimately:

Reduce cost, improve efficiency & minimise waste (30-50% savings in blasting costs, 50% increase in productivity)





PETRONAS Approval Letter – May 2018



Our Reference: ENGG/MCI/CORRES/10.08/2018/02

31st May 2018

JURUNATURE SDN BHD (480488-P)
Suite 4-07, Level 4 AMODA,
22 Jalan Imbi,
55100 Kuala Lumpur.
Attn: Dato' Sri Muhammad Syafiq

Dear Sir,

DRY ICE BLASTING WITH ABRASIVE BY JURUNATURE SBN. BHD.

We are pleased to inform you that PETRONAS Protective Coating Technical Committee (PPCTC) is hereby confirmed that we had carried out technical assessment in terms of performance testing for 'Dry Ice Blasting with Abrasive Technique' by JURUNATURE and its principal according to PTS 15.20.03 Protective Coating and Lining requirement.

The Dry Ice Blasting with Abrasive Technique is now APPROVED for usage at PETRONAS facilities and its subsidiaries with immediate effect until a period of 5 years from the date of this letter.

The blasting technique will be listed under PETRONAS Approved Blasting Technique Master List.

Followings are the conditions that read together with this approval;

- a) *PETRONAS reserves the right to partially or completely withdraw any approval given to the vendor should there is any technical discrepancies found with their services.*
- b) *PETRONAS and its subsidiaries have the right to request for full reimbursement to the vendor on any expenses incurred as a result of service discrepancies that affected the quality of surface preparation for the painting work.*
- c) *The vendor shall provide their utmost workmanship to ensure highest quality and performance rendered for their work.*

Internal
PETROLIAM NASIONAL BERHAD (PETRONAS) (20076-K)
Tower 1, PETRONAS Twin Towers, Kuala Lumpur City Centre, 50088 Kuala Lumpur, Malaysia
T: +(603) 2026 5000, 2051 5000 F: +(603) 2026 5050
www.petronas.com





PETRONAS Approval Letter – May 2018



Page 2 of 2

We are looking forward to your active participation in our energy business.

Thank you,

Yours sincerely,

For **PETROLIAM NASIONAL BERHAD (PETRONAS)**

Muhammad Hawari bin Hasan

Chairman for PETRONAS Protective Coating Technical Committee
Group Technical Solutions
Materials, Corrosion and Inspection (MCI)
Infrastructure, Engineering Department
Group Technical Solutions
Project Delivery & Technology
PETRONAS

C.C

Head
Infrastructure, Engineering
Group Technical Solutions
Project Delivery & Technology

Head
Material, Corrosion and Inspection
Engineering
Group Technical Solutions
Project Delivery & Technology

Custodian (Inspection)
Material, Corrosion and Inspection
Engineering
Group Technical Solutions
Project Delivery & Technology

Internal

PETROLIAM NASIONAL BERHAD (PETRONAS) (20076-K)

Tower 1, PETRONAS Twin Towers, Kuala Lumpur City Centre, 50088 Kuala Lumpur, Malaysia

T: +(603) 2026 5000, 2051 5000 F: +(603) 2026 5050

www.petronas.com





SHELL Technical Assessment – Nov 2016



Technical Assessment of Dry Ice Blasting as surface preparation method for cleaning of steel surfaces and removal of coatings

SR.16.12846

- II -

Restricted

Executive summary

Within Shell assets, there is a tendency to source alternative methods for surface preparation in order to save costs and increase productivity. The common used surface preparation method is abrasive grit blasting which uses compressed air or water to direct a high velocity stream of an abrasive material to clean an object or surface and to prepare it for the application of a coating.

As part of their Fabric Maintenance campaign, Shell Corrib has been looking into other means of surface preparation that could help reducing the optional safety hazard while increasing productivity. They have sourced a new method called Dry Ice Blasting.

As part of the Technology Replication Trust (TRT) third party technology program, the Dry Ice Blasting method was identified as a technology with great potential. To provide global technical approval of this technology, Shell PTE was invited to witness the Dry Ice Blasting process at the Corrib site and evaluate this technology.

Based on the documentation and test trials, Dry Ice Blasting is technically approved as surface preparation method to remove coating layers and corrosion scales to be used for Shell projects and assets.

Restricted

SR.16.12846

November 2016





HUMIDUR Coating System BY ACOTEC



Single Coat - No Primer





HUMIDUR® Single Coating



HUMIDUR® = **HUM**idity + **DUR**ability

ACOTEC = **Anti CO**rrosion **TEC**hnology

Humidur® is the brand of protective and marine coatings developed by Acotec. With 30 years of expertise in anti-corrosion coatings, anti-fouling coatings and top coats, Humidur® offers solutions to a wide variety of markets: the offshore oil and gas market, petrochemical industry, shipping, marine industry and energy market.

Heavy-duty performance and outstanding properties

The system has proven to be maintenance-free when there has been minimal or no mechanical impact.

Humidur® is a system designed to use in all kinds of water and has a high chemical resistance at the same time. The system has proven to be effective in salt, brackish, fresh, drinking and even waste water. It also protects steel tanks and pipes with more aggressive chemicals.

In the marine and shipping industry, the products may also be used in submerged, splash zone and tidal areas and in atmospheric zones. In other words, Humidur® is able to function on the complete structure. This is proven in practice on multiple structures for several decades!

Five Humidur systems covers most structures

1. Successful in all types of water environment
 - Proven system in salt – brackish – fresh water
 - Officially approved for potable drinking water structures
2. Ideal for structures in water
 - Works in fully submerged zone, tidal / splash zone and atmospheric zone
 - Perfect for pipelines, offshore and marine structures, ballast tanks
3. Increased Flow velocity
 - Smooth surface
 - Perfect in moving water – increase flow velocity, capacity





4. Cures under water

- Immediate use of structure
- Minimum downtime
- Unique efficiency in coating of submerged and splash zones!

5. Single-layer system

- 1 layer built up to the requested DFT
 - No primers required
 - Reduced production and application costs substantially
-
- User friendly; min surface preparation
 - 30-year claim-free system and satisfied customers worldwide
 - Ideal solution for Sweating Lines and CUI
 - Surface tolerant: even under minimal surface preparation conditions the coating withstands extreme conditions (adhesion values reach up to 25 MPa)





APPLICATIONS

The manufacturer of Humidur®, Acotec, provides the full service from coating manufacturing, to coating application and quality control in cooperation with its clients. Acotec can provide the full equipment and technical assistance which makes the Humidur® products to the most complete products on the market.





KEY BENEFITS



Cost Effective

- Single Coat
- Minimal surface preparation and shutdown
- No Primer and Top Coat required
- Allows for NDT inspection at 400µm DFT
- 1/3 losses compared to 3 - layer coating system
- Up to 30 Year Warranty

Significant Productivity Increase

- Up to 40% productivity increase over 3-layer system
- No revisit for 2nd and 3rd coat application - 1 day application time vs. min 3 days for 3-layer system
- No intermediate curing times for multiple layers
- Cures Underwater



Increased Window of Application

- Can be applied :
 - In high humidity conditions i.e. as high as 95% Humidity
 - Within a temperature Range -35°C to 150°C
 - To pH levels $0 < \text{pH} < 14$
 - To salt levels $< 65 \text{ mg/m}^2$



Enhanced HSE Management

- It is environmentally friendly (no VOC's, no coal tar, no heavy metals, no isocyanates)
- Eliminates need for multiple solvents/chemical
- No risk of pollution; solvent free - no heavy metals, coal tar or isocyanates
- No leaching when curing under water
- No HSE risk - 100% VOC free
- Minimum risk of explosion due to higher flash point ($>100^\circ\text{C}$)





Case Studies: Offshore Platform Onsite Repair

Detail: Corrosion repair and overcoat with Humidur with minimal preparation

Client: Talisman Energy UK Ltd

Applicator: CAN Offshore Ltd

Date: Feb-Mar 2013

Location: Offshore UK, North Sea





Case Studies: Offshore Platform Nodes Repair

Detail: Coating repairs of nodes by rope-access

Client: Talisman Energy UK Ltd

Applicator: Stork Technical Services

Date: Sep-Oct 2014

Location: Offshore UK, North Sea





Case Studies: Asset Coating Repairs

Detail: Coating repairs of assets
Client: Shell
Applicator: Stork Technical Services
Date: 2015
Location: Nelson Platform, Offshore UK,
North Sea



Support of vessel coated with Humidur®



Backplate of cooler prior to repair

Coating repair with Humidur®





Product Approval @Shell

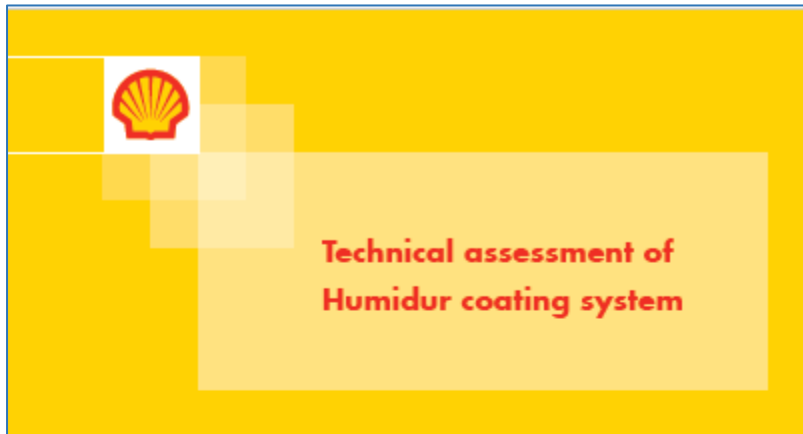

Received fast-tracked SHELL Global approval in May 2016 and currently undergoing Global roll-out for all its facilities & plants.

Executive summary

- Within Shell assets and projects there is a tendency to use alternative coating systems compared to the conventional primer/epoxy midcoat/UV resistant topcoat coating system for atmospheric conditions, especially for maintenance purposes for offshore applications.

One of the options is a maintenance coating system, the Humidur coating system, manufactured by Acotec, Belgium. The Humidur coating product is a single layer surface tolerant 2-component solvent-free modified epoxy coating.

It is the intention to extend the use of this optional maintenance coating system to Shell assets globally. This report describes the technical assessment of the Humidur coating system based on manufacturer information, Shell assets experiences, other track records and (third) laboratory test reports.

It was concluded that Humidur FP can be approved to be used within Shell assets and projects for Sa2^{1/2} blasted steel and provisional for St2 and St3 prepared steel surfaces.

Restricted
SR.16.11493
May 2016





Product Approval @Aramco



Qualification testing of Humidur FP Single for approval to APCS-19C, 09-SAMSS-70

Carried out by INTERTEK
On behalf of SAUDI-ARAMCO

Conclusion

Humidur was approved by Saudi Aramco for use on offshore assets after successfully completing this test program.

This program is far more severe version of the Norsok test program and is especially harsh for polyamine cured epoxy systems such as Humidur as the temperatures are extremely high. Traditional epoxy systems are usually limited to an operating temperature of maximum 60°C in water. Humidur easily passed the cathodic disbondment test at 80°C. In the Norsok test program this test is performed at a temperature of only 23°C.

Moreover, the coating resistance before and after the ageing resistance and seawater immersion was quantified by means of Electrochemical Impedance Spectroscopy. The acceptance criterion was $> 10^8$ ohm.cm². Humidur passed every test with more than $> 10^{11}$ ohm.cm².

Acotec nv

Industrieweg 2

T: +32 52 88 86 80

01/02/2017

Zak B:

F: +32 52 88 86 88

9120 Iersbodegem (Belg)

M: info@acotec.be



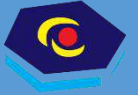

- **Passive Fire Protection Services**
- **JuruFlex - J120 - Jet Fire Jacket System**
- **Fire & Blast Protective Systems**
- **Fire Rated Doors**
- **FRP Grating and Handrails**
- **Welding Electrodes**
- **Field Joint Coating Services**
- **Enertherm Sprayable Insulating Coating**
- **C-Saddle Pipe Supports**
- **Deepwater Capabilities and Remote Inspection**
- **Topside Robotic Inspection**
- **Emission Monitoring and Reporting**
- **Fabrication Works**
- **VSAT Systems and ICT Solutions**

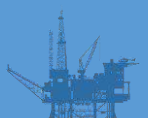



Passive Fire Protection



A cornerstone of **JURUNATURE**'s business is Passive Fire Protection Services (PFP). **JURUNATURE** have developed to become the leading contractor in Malaysia for the supply and application of Epoxy Passive Fire Protection systems. **JURUNATURE** have developed a strong relationship with Jotun, who are one of the world's leading manufacturers of paints, coating and powder coatings, and who have introduced the next generation of epoxy passive fire protection, which offers considerable benefit to the industry.

Jotun introduces Jotachar JF750, the industry's first mesh free next generation solution for hydrocarbon and jet fires. Jotachar JF750 incorporates an advanced fibre matrix, eliminating the need for complex mesh reinforcement. When exposed to a fire, Jotachar JF750 produces a robust and temperature stable insulating char whilst risks associated with incorrect mesh installation are eliminated.

Jotachar's mesh free solution provides significant benefits for owners, fabricators and applicators compared to systems that require mesh reinforcement:

- Increased productivity
- Installation time reduced with up to 50%
- Maintenance cost reduced
- Saves material costs with up to 50%
- Less risk
- Potential one-coat system for 30 or 60 minute jet fire scenarios

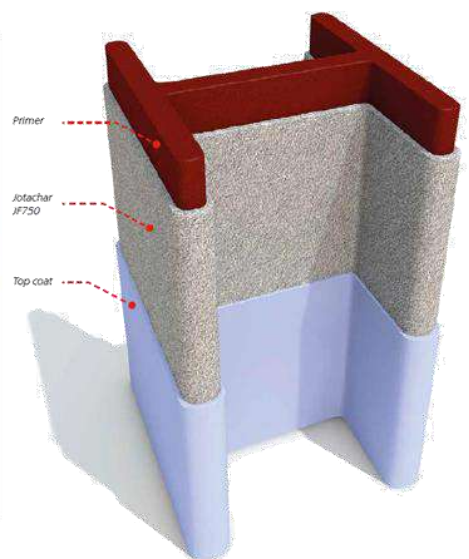
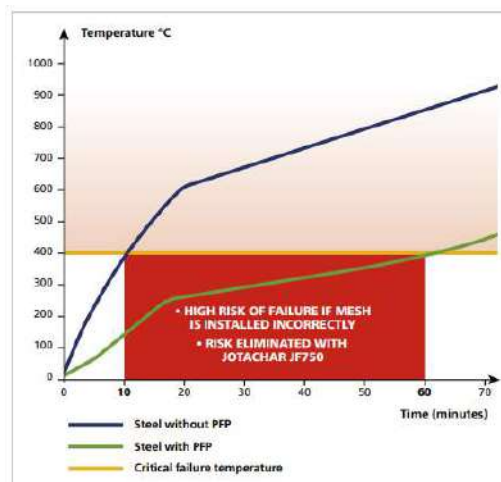



JURUNATURE's PFP Casting System

PROCAST PFP Casting systems. **(Jurunature's own and manufactured)**

For items requiring maintenance, such as valve or flange; removable PFP casting is used. The protection rating provided is determined by the thickness of the PFP application, plus the thickness and type of material it is covering. The PFP thickness is also determined by the fire protection rating requirements of the client.



A foam cut-out for trial fitting to a flange



Valve casting sealed to the quick release connector's flange, to allow uninterrupted access to the quick release connector.



Completed 36" Main SDV, installed and fitted with its **PFP** castings and wet applied **PFP**.



SDV after wet application and all but the flange castings are completed. The flange covers were to be fitted offshore, after installation of the valve.



Valve body after wet application. Note, the nameplate and data plate have been left uncovered. They were later covered by removable PFP access panels.





...(continued) : Installed offshore Peninsular Malaysia





JuruFlex - J120 - Jet Fire Jacket System

JuruFlex-120 A Modern, Wire Free, Easy to Install, Jet Fire Jacket System

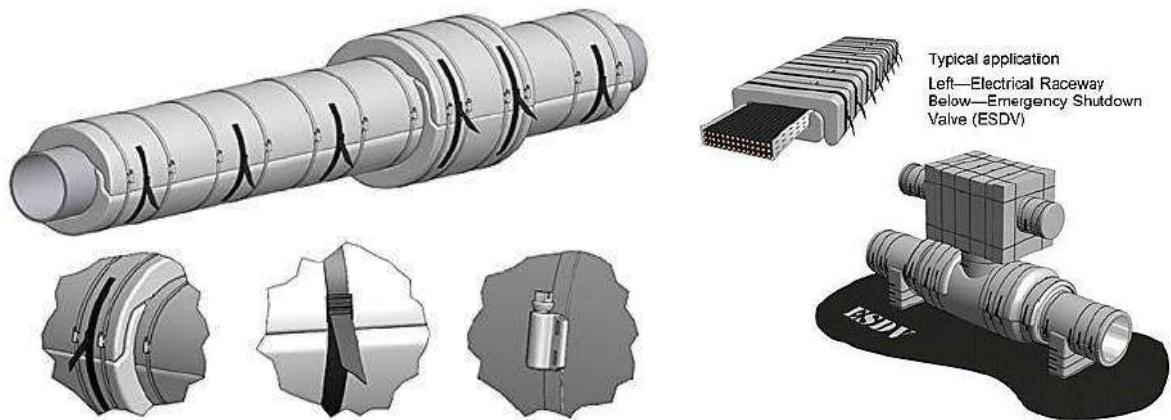

JuruFlex-J120 Jet Fire Jacket System, which offers a modern, wire free, easy to install alternative to industry requirements.

The effects of hydrocarbon fires within the oil & gas industries both on and offshore can be catastrophic and can result in major loss of life and capital investment.

JuruFlex-J120 passive fire protection is a best of breed flexible protection jacket system with quilted construction to facilitate complex structural shapes.

JuruFlex-J120 is designed for rapid installation using the *JURUNATURE* safe-locking securing system and is fully removable and re-installable for inspection and maintenance.

JuruFlex-J120 is a certified system, tested to the new and more onerous jet fire standard ISO 2289921 ("Determination of the resistance to jet fires of passive fire protection materials").

JuruFlex-J120 can be installed around critical plant shutdown equipment such as valves and actuators, pipes and associated equipment, electrical raceways, junction boxes and vessels.

Advantages of **JuruFlex-120**

- Simple to install and remove
- Inspection hatches can be incorporated
- Asbestos free
- Manufactured using non RCF fibre
- All testing witnessed & certified by Lloyd's Register
- J120 certified
- NO lacing wire

Typical **JuruFlex-120** applicators

- Valves & Actuators (ESDVs, MOVs etc)
- Vessels
- Pipework & Flanged Joints
- Electrical Raceways (cable trays & conduits)
- Junction Boxes





Fire & Blast Protective Systems



Mech-Tool Engineering Ltd [MTE] is the leading global supplier of solutions protecting people and equipment from fire, blast and radiant heat hazards for the offshore and onshore oil and gas, nuclear, renewable energy, chemical and petrochemical industries.



JURUNATURE provide Fire & Blast Wall solutions and were the first to fabricate outside MTE premises for Kumang under the supervision of MTE.

Blast Walls are high integrity fully welded gas tight systems manufactured from profiled steel and insulated to achieve the specified fire ratings. They are resistant to overpressures in excess of 7 barg and have been designed and supplied with fire ratings of up to H120 and 60 minute jet fire, type approved by Lloyd's Register. We have performed well over 100 full scale blast tests to prove the validity of the fire wall design procedure.

Blast Relief Systems are tailored to the individual requirements of each project, taking varying aspects of the specification into account to offer the optimum solution.

Fire Walls are high integrity, fully welded gas tight systems manufactured from profiled steel and insulated to achieve specified fire ratings up to H120 and 60 minute jet fire, which are type approved by Lloyds Register. Lightweight prefabricated walls are designed to achieve the most cost-effective and efficient solution to the specified hazard. To prove the validity of the fire wall design procedure we have performed well in excess of 100 full scale fire tests. For simplicity of installation they require no intermediate support steel, whatever the span; and being stainless steel they are maintenance-free.





Fire Rated Doors



Since 1975, Rapp Bomek delivered more than 35,000 doors to oil and gas installations, ships and other projects to Norway • Australia • Brazil • Canada • China • Europe • Korea • Middle East • Russia • Southeast Asia • West Africa • USA

Rapp Bomek designs and manufactures full range of project specific doors:

- **manual-, pneumatic- and electric operated** sliding doors to meet the requirements in SOLAS 74 and IMO FTP code and according to NORSOK standard C-002: M1, M2 and H1.
- Sliding doors product range: NR, A0, A60, H0, H60 and H120.
- **Hinged and sliding, Single and double, Light-duty** A-0/A-60 rated, Super light-duty A0/A60 rated, **Medium-duty** A-0/A-60 rated, **Heavy-duty** A-0/H-120 rated, **Combination doors, fire rated and weather/watertight**, Non-rated, Louvered, Pneumatically operated, Hydraulically operated and Electrically operated



Service and maintenance

- Professional service team of more than 20 highly trained service engineers who can provide installation and maintenance on all types of fire doors and systems/equipment.
- Extensive experience, and the necessary certificates and safety courses required for offshore work and have performed installations, surveys, maintenance and recommendations for upgrading and cost effective improvements
- Developed a "Total Agreement" concept, utilized by many platforms and FPSOs in order to reduce costs for the platform operators with long-term frame agreements with several oil companies for maintenance on fire doors and fire door systems.





FRP Grating and Handrails



JURUNATURE is proud to represent AIMS of the United States, who are the leading supplier of molded fiberglass grating to the offshore oil & gas industry.

A world leader in the fabrication and installation of fiberglass structural systems:

- Wellhead Access Platforms
- Vessel Access Platforms
- Helidecks
- Grating Systems (Wave-Zone / Non-wave Zone)
- Ladders and Handrail Systems (Wave-zone / Non-wave zone)
- Mud mats, Bumpers and Fendering Systems
- Wind walls



AIMS International

- 20+ Years experience for FRP Systems to Offshore Industry
- Recognized leading composites fabricator and FRP engineering design company
- Patented Talon system - Washout warranties for wave-zone
- Developer/ Manufacturer of “Low Drag” Flow Splitter or Fairing
- Leading supplier of platform fendering systems, Vortex Strakes
- Specialized FRP engineering department (3-D Structural Analyses) with In-house 2-D AutoCAD and 3-D design
- Offsite installation services





Welding Electrodes



- **Welding Consumables**
- **Tube, Pipe and Pipe Fittings**
- **Heat Exchanger and Tube Bundles**

The welding company has been the leading manufacturer of high quality welding consumables in Japan for over 50 years. Today with 10 manufacturing and sales bases in Asia, Europe, and the United States, Kobelco are meeting the welding needs of industries throughout the world. Kobelco manufacture welding robots, power sources and equipment which are marked individually or packaged with welding consumables as complete systems. Kobelco’s cornerstone of operations is the QTQ promise “Quality products, Technical support, Quick delivery”.





Field Joint Coatings



In the area of Field Joint Coating, **JURUNATURE** continues to provide best in class service to the industry and through its partnership with RAE Energy, we strive to offer innovative solutions that ensure the Field Joint Coating application remains off the critical path of pipe laying.

Concrete Weight Coating (CWC) Infill Applications

- Mechanical Protection
- Anti-Corrosion Applications
 - Fusion Bonded Epoxy
 - Liquid Epoxy
- Three Layer Polypropylene (3LPP) Application
- Serviwrap Anti Corrosion
- Cold Applied Tape System

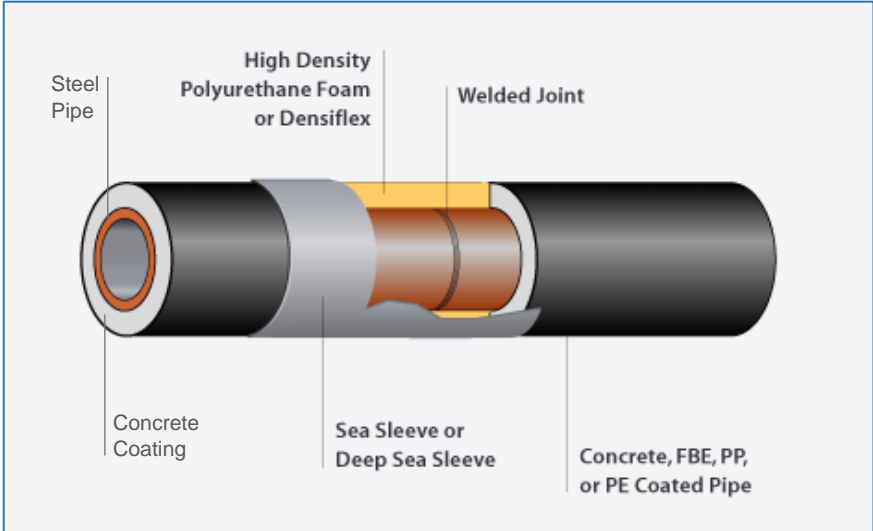



Enerthem Sprayable Insulating Coating



Ti220 Performance and Specification
EnoTherm Ti220 was designed in response to all the restrictions of other Thermal Insulation coating on the market.

Ti220 is a water borne system that can be spray applied to film thickness of up to 6mm in a single coat. The material has a temperature range of **-90°C to +220° C**



Foam Structure



Water beads at surface



Can be bent and return to its original shape



Multi-Layered



Large thickness can be obtained without cracking



Advanced Sprayable Insulating Coating

Very Low thermal conductivity

Low Overall Heat Transfer Coefficient

Thermal Diffusivity

Hygrophobic/Waterborne

Elastomeric

Volumetric Capacity

No Discolouration

EnoTherm Ti220 has Hygrophobic properties ideal for use as part of a system for the protection of steel against **Corrosion Under Insulation (CUI)**.

Large Industrial oven, Project time line 3 days.
14% energy savings

Before	After

Large Incinerator, Heat Exchanger, and fryer system (180m²). Project timeline in 3 days.
7% energy savings

Before	After





C-Saddle Pipe Supports

C-SADDLE™

A LOW-FRICTION NON-CORROSIVE WEAR PAD SYSTEM



C-SADDLES ARE THE NEXT GENERATION PROTECTION BETWEEN THE PIPE AND PIPE SUPPORT THAT STOPS DANGEROUS CREVICE CORROSION.

C-Saddle uses a flat sliding surface between the saddle and pipe support - the next generation of pipe/support protection. Numerous advantages of product, including ease of installation, no hot work requirements and providing a long term maintenance free solution.

C-Saddle utilize a non-corroding Fiberglass Reinforced Pipe (FRP) support base that holds the specially designed non-corroding Nylatron NSM Bearing Pad in place. Major Advantages of the C-Saddle System are;

- C-Saddle, with its peel and stick feature, takes less than a minute to install and requires no mixing, special tools or training. Minimum pipe preparation is required.
- C-Saddle utilize a very high bond strength adhesive along with Nylatron NSM Bearing Pad that will keep the C-Saddle firmly secured to the pipe, when overcoming the friction between the pipe and pipe support associated with pipe movement.
- Most traditional “insulators” because of their design create excessively high point loads between the pipe and the pipe support. In most cases the point loads created have PSI’s that exceed the yield strength of the insulating materials. The flat surface of the C-Saddle’s Nylatron NSM Bearing Pad increases the loading area on the pipe support. PSI loadings can be reduced over 90% extending the life of the C-Saddle.
- The flat surfaces of the Nylatron NSM Bearing Pad on the C-Saddle will keep the C-Saddle firmly in place in the high vibration areas. C-Saddle will not walk out from under your pipe.





Deepwater Capabilities and Remote Inspection

DEEP DOWN

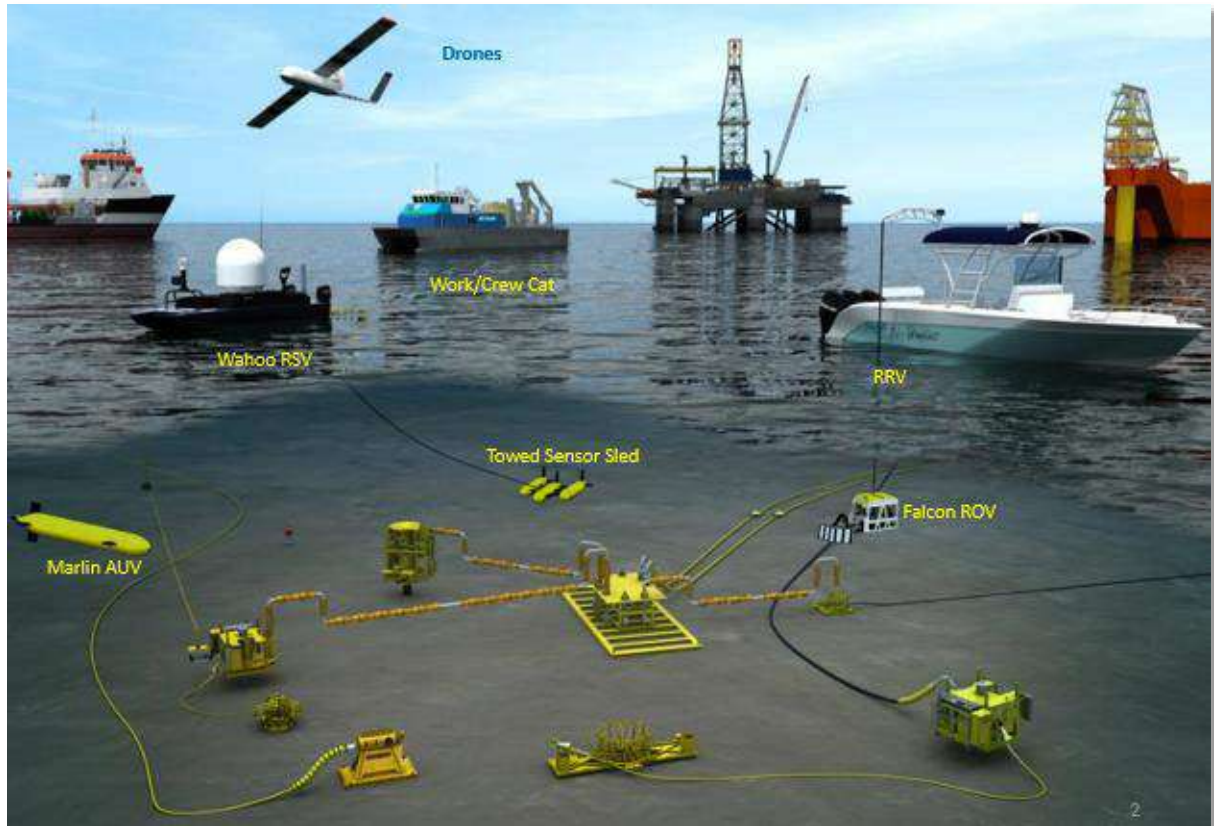

DDI AUV Capabilities

- DDI AUV (Autonomous Underwater Vehicle) is launched from either davit from Vessel, beach, or from remote location via the Wahoo Remote Surface Vessel (RSV) which tows the Marlin to location with no AUV fuel drain and towed back to shore
- Marlin operates either as AUV under full autonomy or as a tether less observation vehicle driven remotely anywhere in the work by unmanned Wahoo RSV or by minimally manned Fast Response Vessel (FRV) or minimally manned Work Cat
- Ships with Wahoo in 40' container anywhere in the world
- Marlin AUV capabilities are:
 - 3D bottom mapping, Oil seepage detection on bottom, As built Pipeline Survey
 - Leak Detection, Loop Current Monitoring, Acoustic vessel surveillance and detection/mapping
 - Live touchdown monitoring for pipeline installation when working with Wahoo
 - Hydro thermal vent searching and mapping, Wreck detection and Perimeter security patrol





Wahoo RSV Capabilities



Wahoo RSV

- DDI Wahoo Remote Surface Vessel (RSV) is launched from either Davit from larger mother ship, dock crane, or boat Ramp the beach or from Remote location.
- Wahoo ships with Marlin in 40' container anywhere in the world.
- Wahoo operates completely remotely anywhere in the world and has multiple communication methods. It communicates with Subsea Devices with its own on board USBL transmitter and receiver and is driven remotely anywhere in the work by unmanned Wahoo RSV
- It has the ability to give commands to AUVs giving them ROV capability and can communicate with any acoustic based system remotely.
- Its functions are:
 - Data Truck from AUVs allowing date to be transmitted live or more frequently than waiting for AUV to be recovered
 - Give commands to AUVs remotely
 - Recover and deploy AUVs
 - Deploy simple based ROV
 - Man over board (MOB) rescue or recovery
 - Deploy and tow various packages and gather information from those package and transmit that information real time remotely.

DDI TASK (Tactical Advanced Surveillance Krawler) is a Remote operated vehicle from any cell, RC, and wi-fi based system

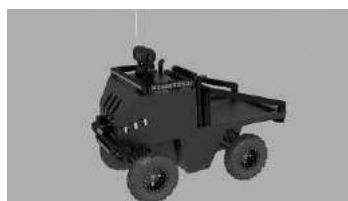



Topside Robotic Inspection



CAPABILITIES

- Independent Robotically Inspections
- ISO 9001:2008 and VCA approved
- Certified inspectors and high-tech equipment
- Real-time followed from ground level
- Minimize downtime during shutdowns
- Safe, time efficient and cost effective

Robots

- Small, remote-controlled, lightweight
- Climb tank walls, ceilings, and pipe
- Excellent for cylindrical objects and uneven or flat surfaces
- Interchangeable equipment

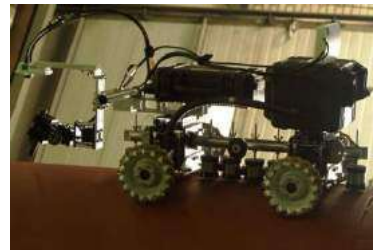

RISQ robotics performs independent inspections for e.g. the following industries:

- Oil, gas and chemical industries
- Power plants
- Wind farms on and offshore
- Maritime
- Defense facilities, navy





Emission Monitoring and Reporting

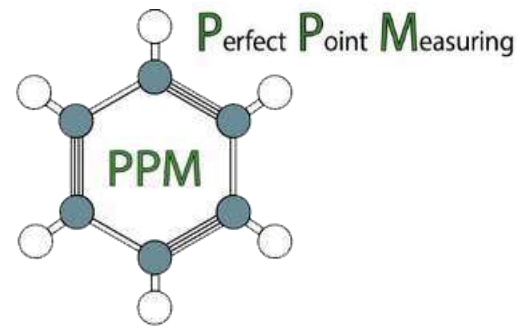

Perfect Point Measuring

- First operations in 1996
- Experts in emission monitoring

Services

- Leak detection (LDAR), SLDAR and flare emission monitoring
- Loss analyses and improvement service
- Asset and Drawings Management Solution
- Energy projects

LDAR

- Leak Detection And Repair (Reporting)
- To control and to reduce fugitive emissions
- Measurements with TVA and Gasfindcamera
- Point by point measuring



SLDAR

- Smart Leak Detection And Repair (Reporting)
- Detect emissions with FLIR (GF320) to find leaks and then measure with TVA Tool.
- SLDAR is more quicker than regular LDAR measurement so it's more cost efficient.

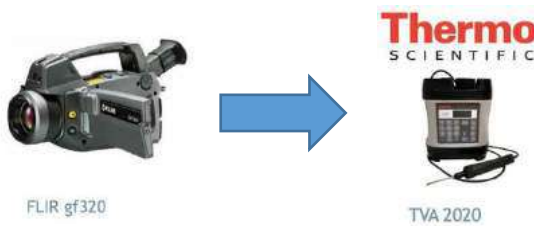

Converting to TPD

Convert drawings to TPD Software and capture leak data for reporting and repair order.

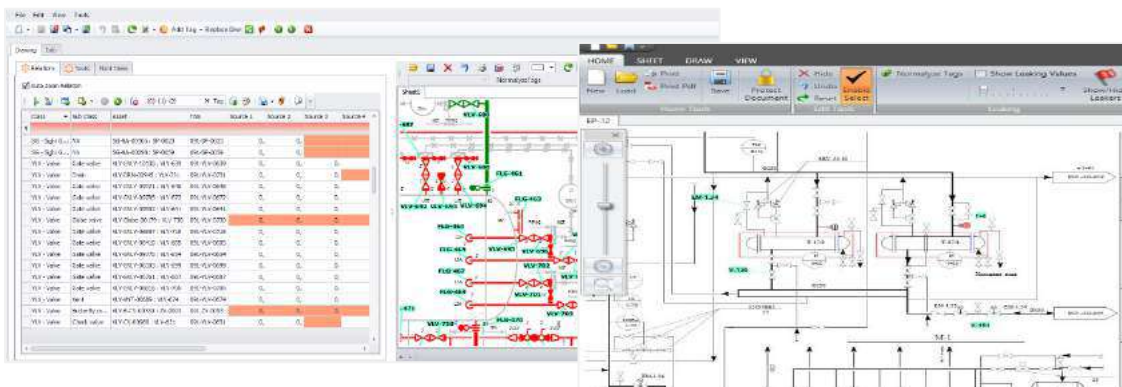



Fabrication Works



- Structural Fabrication
- Piping & Mechanical
- Electrical & Instrumentation
- Blasting & Painting

JURUNATURE's goal is to provide clients in the fabrication industry the highest quality fabrication in the most timely and efficient manner possible. The number one priority is responsive, personalized service regardless of job size. The company has built an enviable reputation through close client cooperation and the consistent delivery of quality products on time and on budget.

Responsive, personalized service on the fast track

JURUNATURE has extensive experience in fast track fabrication contracts. The company responds quickly with personalized service. The net result is a company that works closely with its clients to meet the critical requirements of contemporary construction methods.





VSAT Systems and ICT Solutions



VSAT Systems

JURUNATURE continues to provide best in class service to the industry and through its partnership with ITC Global which is the world's leading satellite network for highly connected remote operations.

We specialize in satellite-based communications for industrial operations in extreme environments, including deep-water energy exploration, remote mining and transoceanic shipping. Today our partner, ITC Global is the number one provider of satellite communications networks to the mining industry and among the top three providers to the oil and gas industry.



ICT Solutions

JURUNATURE is proudly to present our ICT technology products and services that offer comprehensive solutions including the provision of research, design, development, marketing and maintenance services or supply chain solutions, turnkey software development for other business application, professional IT services, hardware and software products implementation.

Furthermore, we provide consultancy service to clients regarding technical, operational and project management for their holistic systems. These include, but not limited to, issues on back-end integration, security issues and online strategy. The Company services large multinational companies on their worldwide integration compliance.



DELL EMC





HEALTH, SAFETY & ENVIRONMENT



At **JURUNATURE**, we believe that Health & Safety forms an essential priority in conducting our business.

The health, safety and well-being of our employees is of utmost importance and as a company, we continually work to ensure all employees place the same emphasis towards health and safety during the course of conducting our business. We also firmly believe that the co-operation and commitment of all employees is essential in achieving the highest standard in Health, Safety and Environment management.

In ensuring a sustainable safety culture, we empower our staff to continually improve and spread the safety message by ensuring they themselves work safely and in accordance with the company's safety procedure requirements and legislative requirements.

In pursuing our goal of "Zero Harm to People, Damage to Assets and Environment".





JURUNATURE is committed to the following:

- Clear identification of work and carrying out a detailed risk assessment and making sure relevant information about work place hazards and their control measure are available to our employees and business partners at all times
- Making sure that Safety, Health and Environment obligations are precisely determined and communicated
- Ensuring that all our employees and business partners are provided with information applicable to legislative standards and requirements
- Carrying out exhaustive audit and reviews of our sites to ensure full compliance
- Carrying out routine senior management and board reviews of safety performance and to initiate counteractive actions as necessary
- Ensuring our employees and business partners are involved and consulted on all safety matters
- Ensuring sufficient resources are made available to achieve the objectives of the companies policies and procedures

JURUNATURE strives to uphold the health safety & environmental aspects in its manufacturing and business operations by:

- Complying to ISO 14001 & OHSAS 18001 standard requirements, applicable legal requirements, as well as client requirements with regards to HSE and shall make available all documents, services and facilities related to HSE issues so as to enable proper performance of HSE related activities
- Preventing pollution, injury and ill-health protect its employees, the environment and all third parties including their equipment's from any hazard that may arise as a result of the WORK
- Continuously improving the HSEMS and ensuring its effective implementation for continual improvement
- Conserving natural resources from extinction.





Major HSE Appreciation





Other Project HSE Awards





QUALITY ASSURANCE & CONTROL

Quality

Our prime objective is customer satisfaction and confidence. This is centered on the products we market and the product support services we are able to provide our customers.

We are fully committed to the concept of Total Quality Management and seek continuous improvement in all of our businesses and operations. In our quest for excellence, we recognize that the co-operation of our employees and our business partners is vital.

We have developed our Quality Culture based upon open and honest communication. We believe in establishing long term partnerships with customers, employees, suppliers and we manage our business in an open manner. We have programmes in place whereby our employees are encouraged to review, develop and contribute fully, towards improving all our processes. We bring our experience, best practices and tools to be applied to our business partner's specific business requirements.

Some highlights of our quality system are:

- A quality culture that stands for delighted business partners, committed employees and continuous improvement
- Proven practices
- Striving to meet our goal of Zero Defects
- ISO 9001:2000 since June 2008





Quality Policy

JURUNATURE strives to become a vast and dynamic business organization by:

- Complying to or surpassing the ISO 9001 standard requirement, applicable legal requirement, as well as client requirements
- Continuously improve the effectiveness of the JURUNATURE Quality Management System
- Ensuring quality of production services that meets the quality standard at a competitive price
- Providing a conducive & proper work environment in order to achieve
- JURUNATURE's Quality Policy
- Enhance the knowledge, know-how and motivation of our employees depending on the development of knowledge and technology applicable to JURUNATURE's operation, to make sure continuous client satisfaction.





CLIENTELES & KEY ACCOUNTS



PETRONAS



CARIGALI HESS

ExxonMobil



Lundin
Petroleum





KEY INTERNATIONAL PARTNERS

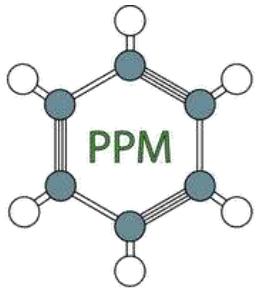



LICENSES AND CERTIFICATIONS

CIDB MALAYSIA

DEWAN PERNIAGAAN MELAYU MALAYSIA

ISO 9001:2008

ISO 14001:2004

MOF CERTIFICATION

OHSAS 18001:2007

PETRONAS LICENSES

